



AHP-301CPV  
Cold/Warm Plate  
Product Manual  
Volume 1.1

tecca



# Table of Contents

<b>Page</b>	<b>Description</b>
1	Cover Page
2	Left Intentionally Blank
3	Table of Contents
4	AHP-301CPV
5	What's in the Box?
6	Safety Features and Standards
7	Warnings
8	How do I use it ?? NOW !!
9	Front Panel Layout
10	Physical Layout
11	Adjusting the Set Point Temperature
11	Initiating Tune to Set Point
11	Changing from degrees C to F
12	Over-Temperature Safety
12	Using the external sensor
13	Adaptive Fan Control
13	Guaranteed Soak and Ramp Tracking Limits
14	Controller Modes – Entry Method & Passwords
15	Basic Operator Mode, Normal day to day operation
16	Programming Mode
17	Example Profile
18	Ramp/Soak program codes
19	Notes
20	Back Page

# AHP-301CPV

## Cooling and Heating Plate



# What's in the Box ???



AHP-301CPV  
Cold/Warm Plate

Power Cord



Remote RTD Connector

Software  
and  
Manuals

AHP-301CPV Product Manual and EasyLog Product Manual in print and CD, TECA EasyLog software, DotNet Framework, iTools Engineering Studio, iTools driver, Sample ramp/soak programs, TECA TC-4300 Operations Manual, AHP-301CPV Literature

# Safety Features and Standards

- Automatic recovery to set point after regain of power
- Program resume after regain of power
- Rear Condensate Guard
- Programmable over-temperature limits
- Hardwired safety overheat limits (95 C) will shut down everything and trip an alarm. System automatically recovers after cool down.
- System shut down upon sensor break, over and under range
- NRTL evaluated (ETL) to UL (Pending)
- NRTL evaluated (ETL) to CSA (Pending)
- CE (Pending)

# Warnings

- Read and understand the manuals included with the product.
- This product can get very COLD and very HOT. CAUTION should be used at all times. Do not touch any surface which may be at an extreme temperature range.
- Return plate to ambient temperature prior to adding or removing materials.
- This product should be serviced by a qualified technician.
- Caution: Risk of electrical shock. Always disconnect the power when performing any servicing.
- Exercise every possible caution if cooling any type of hazardous material. Follow all precautions necessary for the particular materials being cooled.
- Use the external sensor feature with caution. There may be a significant time delay between the cold plate temperature and the sensor temperature causing potentially dangerous overheat or freezing conditions.

## How do I use it? NOW!

Step 1: Locate the unit on a flat level surface like a bench. Make sure you have some room around it for good airflow.

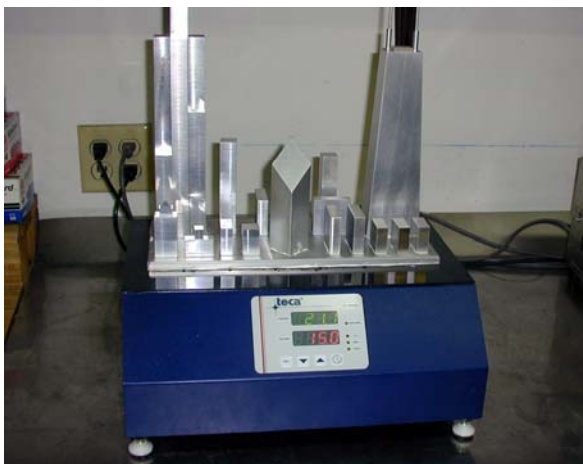

**DO**  
Give it room to “Breath”

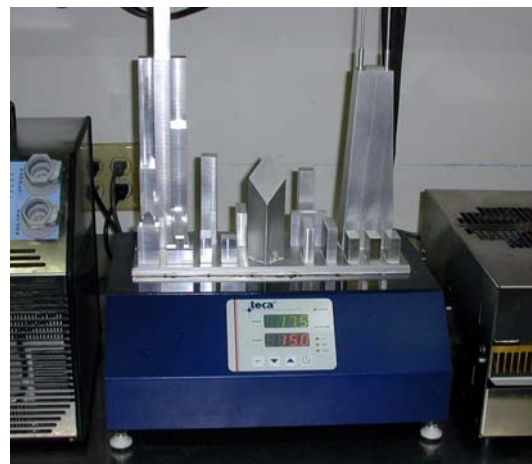

**DON'T**  
Pile lots of stuff all around it.

Step 2: Plug the cord in the back of the unit, the other end in the wall outlet and turn the unit on. The temperature controller will turn on, the fan will start to spin and the plate will begin to approach the set temperature.



Step 3: Now What? Now to add what you're cooling.



Put something on the cold plate and adjust the set point using the arrow keys.

## Front Panel Layout

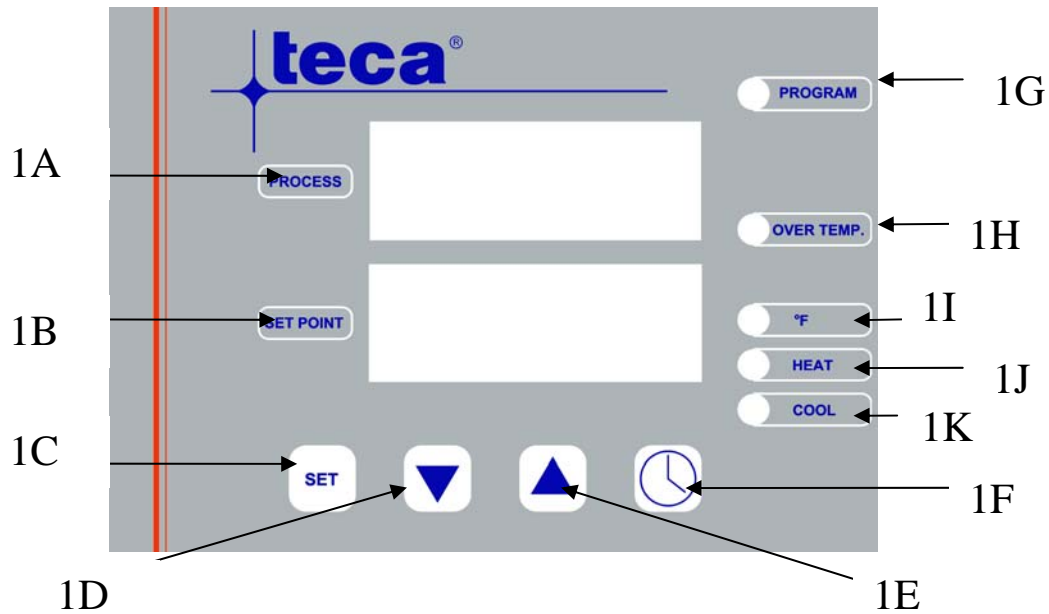

- 1A Process (or fluid) Temperature
- 1B Set Point Temperature
- 1C “Set” - Used in Programming
- 1D “Down Arrow” – Adjust Temperature down
- 1E “Up Arrow” - Adjust Temperature up
- 1F “Clock Symbol” – Used for programming and initiating program
- 1G This yellow light is ON when running a program
- 1H This red light will be ON during an overheat condition and flash after recovery until manually reset.
- 1I This light is ON when the controller is displaying degrees F.
- 1J This light is ON when heating.
- 1K This light is ON when cooling.

## Physical Layout

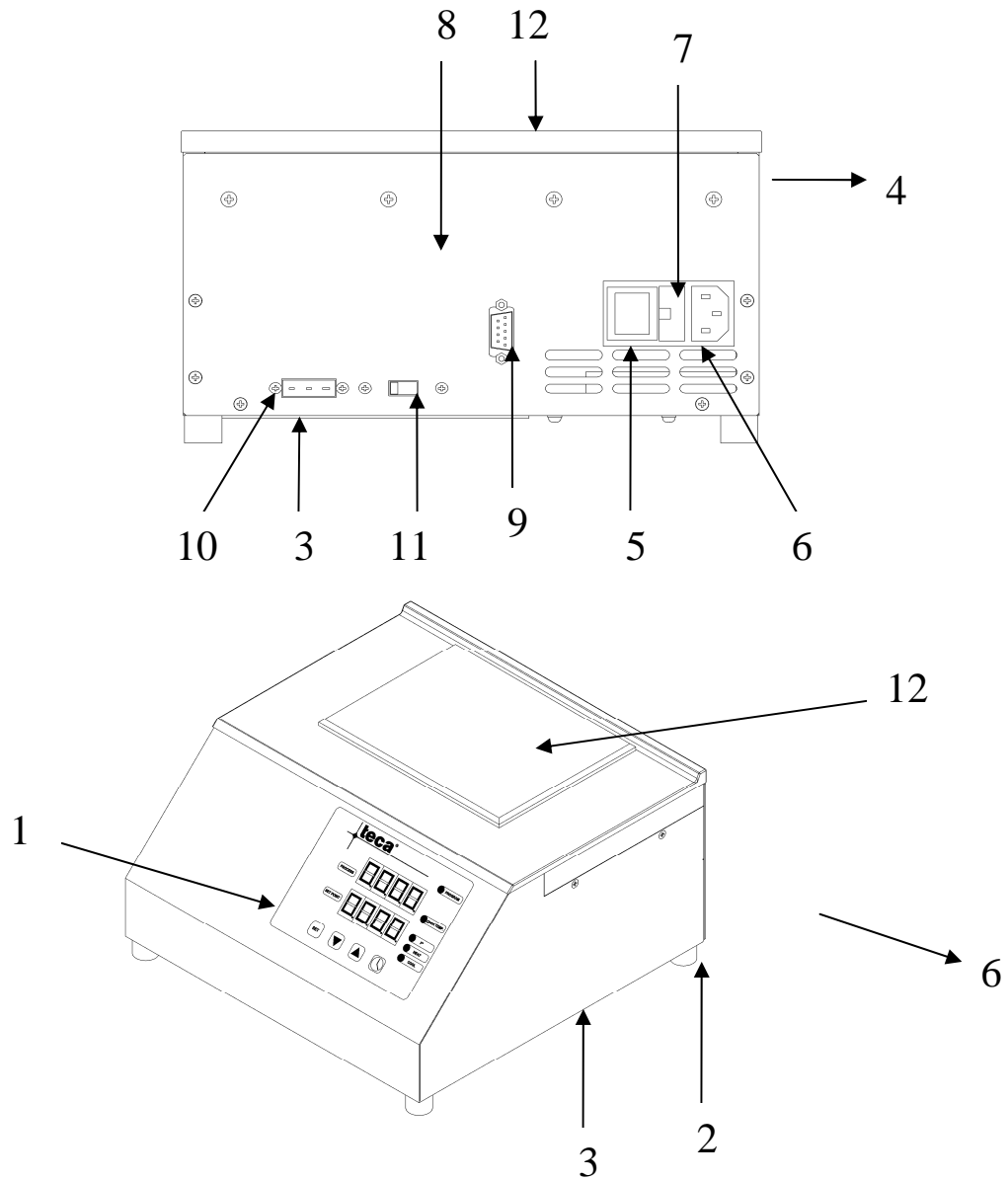

- |   |               |    |                                    |
|---|---------------|----|------------------------------------|
| 1 | Front Panel   | 7  | Fuse (5 x 20 mm, slow blow, 5 amp) |
| 2 | Feet          | 8  | Nameplate                          |
| 3 | Air Intake    | 9  | RS-232 port                        |
| 4 | Air Exhaust   | 10 | External RTD sensor connector      |
| 5 | On-Off Switch | 11 | Internal/external RTD switch       |
| 6 | AC Input      | 12 | Cold Plate Surface                 |

## Adjusting the Set Point Temperature

The Set Point is adjusted by pressing the up or down arrow keys.

## Initiating the Auto Tune function

The Auto Tune function adjusts specific control parameters to provide good control at the specific set point based upon the reaction of the system to the cooling device. These parameters will be different for different systems and for different circumstances within the same system. These circumstances include changing set point and load.

**To set the Auto Tune** press the “set” button then use the arrow keys to set the process to “on”. The set point should say “OPt”. Press the “set” button again. Wait for the display to clear, about 5-10 seconds, and the temperatures to return in the display. The “process” display will alternately flash “OPt” and a temperature until the tuning process is complete.



## Changing temperature indication from C to F

Change the P1 parameter in the configuration level, CnF from 7 to 15. See page 14 for instructions regarding Controller Modes.

## Over Temperature Safety

When an over temperature condition occurs the following will happen:

- The OVER TEMP light will be on.
- System heating and cooling will be disabled
- The pump reset function will be disabled
- If a program is running it will be placed in the “hold” mode

When the condition has cleared normal operation will resume. Heating and cooling will be enabled. It will be possible to reset the pump. The OVER TEMP light will flash until the over temperature condition has been acknowledged using the L.rS parameter in the Basic Mode.

## Using the external RTD sensor

Caution!! Use the external sensor feature with caution. There may be a large time delay between the fluid and the sensor temperatures causing overheating and under-cooling conditions. Fully evaluate the system conditions prior to and during the use of this feature. The RTD is a three wire, 100 ohm, single element, Class A.

Identify where and how you wish to use the external sensor. Take special consideration and thought with respect to system safety. The connector and switch directly behind the controller corresponds to its remote sensor.



Connect the sensor to the back of the chiller, slide the selector switch towards the connector, turn the unit on and verify the function and safety.

A faulty or disconnected RTD is signaled on the display as % % % %

## **Adaptive Fan Control**

Adaptive Fan Control is a special feature designed to improve overall temperature control and user comfort while maintaining maximum performance when needed. The most evident characteristic is the reduced fan noise as the system approaches set point. The fan speed is directly related to the amount of cooling required. This feature has been factory preset. Changes, while not recommended, can be made within the “Set-Up Operator” mode described later in this manual. Detailed information is found in the TC-4300 Operators Manual.

## **Guaranteed Soak and Ramp Tracking Limits**

For the Guaranteed Soak Limit function enter the configuration level, CnF and change the P46 parameter to anywhere from 0.1 to 100.0 degrees C or F. Example: SP=70, P46=2.5, the program waits when  $PV > 72.5$  or  $PV < 67.5$ . Setting to OFF will disable this function.

Parameters P44 and P45 respectively set the Low and High Tracking limits. Setting to OFF disables these functions.

## Controller Modes

Warning: There are many parameters which can be changed in each mode. Those used in normal day to day operation have been described in previous sections. Do not make changes to any parameters unless it is covered in this manual. Other changes may alter the function of the system in an inappropriate and/or unsafe manner.

Mode	Code	Description
Basic Operator	OP.b	From this level an operator can change set point, force an auto tuning process, start a predefined program, and reset the pump.
Program Editing	OP.P	In this level individual program segments are defined, as well as the number of program cycles.
Set Up Operator	OP.S	From this level an operator can set PID parameters, set point limits, and other key operational parameters. Use with caution.
Configuration	CnF	This is the level for factory configuration.
Input Calibration	I.CL	This is the level for access calibration parameters.

\* To switch controller modes, press the ⌚ and **SET** pushbuttons for more than 3 s. The display will soon show **OPr** and the current operational mode. Press the ▲ or ▼ pushbutton to select the new level.

\*To confirm the selection press the **SET** pushbutton.

\***OP.S [ 1 ], OP.P[4 15],** and **[nF** each have their own pass code for level access. If the selection is other than **OP.b** The display will show display **PASS** and **----** . Press the ▲ or ▼ pushbutton to set the proper password. **Passwords:** OP.S – 1 OP.P – 2 A.CL, CnF, I.CL – 415 Press **SET** to confirm.

\*To inspect or modify parameters press **SET** key. To modify a selection use the ▲ or ▼ buttons. Press **SET** again to store the new value and to advance to the next parameter.

\*Push ⌚ to scroll backwards through parameters without storing them.

\*If no button is pushed for 10 seconds the normal display will appear without modifying the last parameter

## Basic Operator Mode (Normal, day to day operation)



To change the set point:

- Press ▼ or ▲ pushbutton for more than 1.5 s to begin modifying the set point.
- Continue until the desired set point has been reached.
- The new set point will be loaded automatically after a 2 second delay.
- By pressing  or **SET** it is possible to abort the modification..

To begin control optimization:

- Change the setpoint to the desired temperature
- Press **SET** to view and scroll thru the parameters in the lower display until you find Opt.
- Press ▼ or ▲ to change the Off in the top screen to On
- Press **SET** again to store the new value.
- The display will return to normal in 5 to 10 seconds.
- During the optimization process the upper display will alternate between the actual process temperature and Opt.
- The display will return to normal when the control optimization process is complete.

To begin the Ramp/Soak Program:

- Press **SET** to view and scroll thru the parameters in the lower display until you find nPRg. Select the program you wish to run and press **SET**
- Press the  button on the front panel for 2 – 3 seconds to start the ramp soak program
- Press the  button on the front panel for 2 – 3 seconds to stop the ramp soak program

# Programming Mode

## The Basics:

- There are 32 segments available in 4 programs of 8 segments, 2 programs of 16 segments, 1 program of 32 segments
- Set Points - What temperature do you want to get to? Initial set points are required for every program. Target set points are required for every segment.
- Actions are required for each segment
- Ramp Rates - How fast would you like to get there?
- Dwell Times – How long do you want to stay there?
- Programming can be done from the front panel or software

## The Software:

- TECA EZLog is a software package which helps you to build ramp soak programs, set temperatures, tune to set point, view & record data.
- iTools Engineering Studio from Eurotherm is a much more complex software for making many more changes to the temperature controller than just the ramp/soak programs. Only the experienced should work with this. Usually there is no need to do so. Changing the wrong parameter can cause system failure which is not covered under the warranty. Use with caution.
- Eurotherm iTools OPC Server optional, not included (for connection to Labview, etc)

## The Manual Method:

- The specific definitions for each segment parameter are shown in the following pages.
- Each segment is identified by a number.
- To select a program to edit, modify the nPrg parameter in the basic mode.
- Then access the “Program edit operative mode” to address each parameter of each segment in order.

# Example Profile

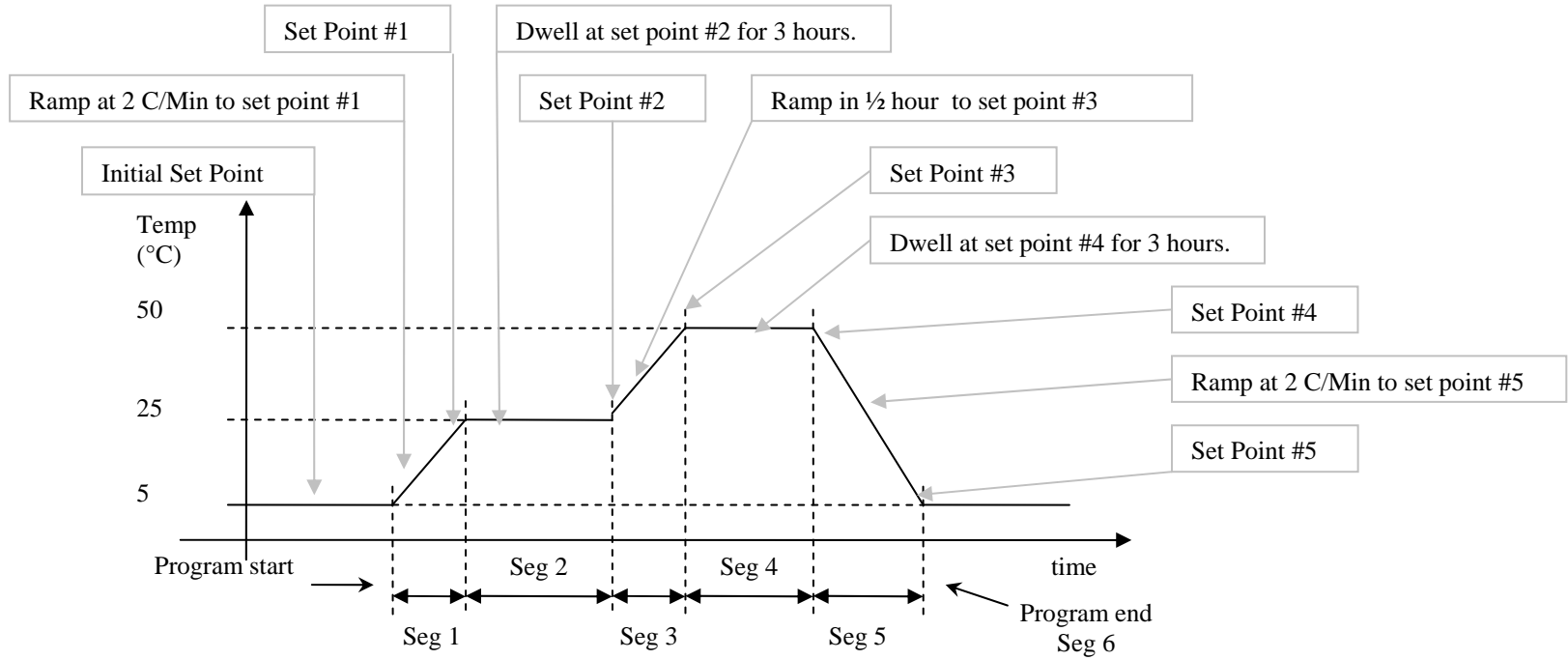

Segment			Target Set Point		Temperature	Action				Elapsed
Symbol	Description	Value	Symbol	Description	(°C)	Symbol	Description	Value	Units	Time
			itSp	Initial Set Point	5		dwell			
Seg	Segment #	1	Sp. 1	Set Point 1	25	rr. 1	Ramp at a defined rate	2	C/min	0.5
Seg	Segment #	2	Sp. 2	Set Point 2	25	rH. 2	Dwell for defined time	3	Hours: minutes	3
Seg	Segment #	3	Sp. 3	Set Point 3	50	TH. 3	Ramp in defined time	0.5	hours	0.5
Seg	Segment #	4	Sp. 4	Set Point 4	50	TH. 4	Dwell for defined time	3	Hours: minutes	3
Seg	Segment #	5	Sp. 5	Set Point 5	5	rr. 5	Ramp at a defined rate	2	C/min	1.4
Seg	Segment #	6	Sp. 6	Set Point 6	END					

Symbols and Definitions				
Parameter	Meaning	Range	Available	Alterable
nPrg	number of the selected program	from 1 to 4	always available	only when the programmer state is idle
Seg	number of the segment in execution	from 1 to 8	only when the programmer state is run or hold	never
rt.	remaining time to the end of the program This value refers to the time remaining to the end of the current execution, regardless the programmed number of executions	- from 1 second to 99 min 59 sec the upper display shows 12.30 (12 min 30 sec) the lower display shows rt.S - from 1 h 40 min to 99 h 59 min the upper display shows 18.45 (18 h 45 min) the lower display shows rt.H - from 100 to 9999 hours the upper display shows 125 (125 h) the lower display shows rt.H - over 9999 hours the upper display shows 0000 the lower display shows rt.H	only when the programmer state is run or hold	never
r.rpt	remaining repetitions before the end of the program	- from 0 to 9999 and then <i>inF</i> The figure shows the remaining repetitions after the current execution. For example 0 means that the program stops at the end of the current execution, while <i>inF</i> means that the device is set for endless repetitions.	only when the programmer state is run or hold and the "Program execution repetitions" parameter is different from 0	Never
Rpt	time remaining to the end of the program, considering also the remaining repetitions	- from 1 second to 99 min 59 sec: the upper display shows 12.30 (12 min 30 sec) the lower display shows rpt.S - from 1 h 40 min to 99 h 59 min the upper display shows 18.45 (18 h 45 min) the lower display shows <i>rPt.H</i> - from 100 to 9999 hours the upper display shows 125 (125 h) the lower display shows <i>rPt.H</i> - over 9999 hours the upper display shows %%%% the lower display shows <i>rPt.H</i>	only when the programmer state is run or hold and the "Program execution repetitions" parameter is different from 0	Never
itSp	setpoint is the setpoint used by the programmer during the "idle" state.	OFF, and then from rL (setpoint low limit) to rH (setpoint high limit) If set to OFF control outputs will be disabled during the "idle" state. At a program start, the setpoint will be aligned to measure value and then ramp to SP: 1.	always	only when the programmer state is idle
Sp.1	target setpoint of the first segment. This parameter is used also to select the segment type: - setting it equal to the previous setpoint creates a dwell segment	from rL (setpoint low limit) to rH (setpoint high limit)	always	only when the programmer state is idle
t. 1 or rr. 1	duration or ramp rate of the first segment	from 1 sec to 99 min 59 sec (the lower display shows t.s. 1) from 1 min to 99 h 59 min (the lower display shows t.H 1) from 0.1 to 3000 engineering units (°C or °F) per minute (the lower display shows rr. 1) Use the up or down arrow buton to select the desired value within the current range. To change the range, travel to the high or low limit, release and press again the up or down key. The lower display will change to point out the next or previous available range.	always	only when the programmer state is idle
Sp.2	target set point of the second segment. This parameter is also used to select the segment type: - setting it equal to the previous setpoint creates a dwell segment - setting it different from the previous setpoint creates a ramp segment	End, and then from rL (set point low limit) to rH (set point high limit) The <i>End</i> value, selectable from the second to the seventh set point, is used to end the program before the last segment.	always	only when the programmer state is idle
Rpt	number of program repetitions of the selected program	- from 0 to 9999 and then <i>inF</i> The figure expresses the repetitions after the first execution. Example: If 2 is selected, the program will be executed 3 times, while <i>inF</i> means that the device is set for endless reps.	always	only when the programmer state is idle

Then E. 2 (or rr. 2), SP. 3, E. 3 (or rr. 3), ..., SP. 8, E. 8 (or rr. 8) as above.



