

# Product Information Packet

## Model AHP-1 800XP-1

Solid State, NEMA 4X, Class I Div 2,

Air Conditioner for Remoter Temperature Control

Part #0-0170-2-004

Thank you for your purchase. Information has been enclosed regarding the installation, specifications, and wiring of your solid-state assembly. Please read and follow all instructions carefully before installation. Only qualified technicians should install this equipment.

If you have any questions regarding your equipment, please do not hesitate to call us at 773-342-4900, and we will be happy to assist you. We are open from 8:00 am-4:30 pm Central Time.

Included in this packet you will find:

Installation Notes for Air Conditioners

Product Literature and Specifications

Assembly Drawing # 1800-B-A18

Wiring Drawing # 1800-A-E109

Installation Drawing # 1800-A-F52

Warranty Information

The logo for Teca, featuring the word "teca" in a bold, lowercase, sans-serif font. To the left of the text is a stylized graphic element consisting of a vertical line and a horizontal line meeting at a point, forming a shape similar to a four-pointed star or a corner bracket.

**ThermoElectric Cooling America Corporation**  
4048 W. Schubert Avenue • Chicago, IL (U.S.A.) 60639  
Ph: 773/342-4900 Fx: 773/342-0191  
sales@thermoelectric.com www.thermoelectric.com

# Important Installation Notes for Air Conditioners

**Mounting Styles:** Both 'thru mount' and 'flush mount' units can be positioned in any orientation and on any enclosure surface. It is important to consider interior air flow patterns when determining the mounting location. Also of importance is an unrestricted flow of ambient air thru the hot side heat exchanger. Ease of access and inspection must be considered for those applications in particularly severe environments which may require occasional maintenance.

## Vertical (Side/Front/Back) Mounting:

Vertical mounting refers to the vertical direction of the cold side or interior fins and is recommended for applications with high humidity, poor and incomplete cabinet seals or any condition which may cause the cold side fins to be maintained at temperatures below the dew point for long periods of time allowing for the formation of condensation. The vertical fin direction provides a drip path whereupon condensation can be collected via a moisture removal system (standard on FHP-units) or a drip pan positioned below the cold side fins. Drip pans are optional for thru mount units.

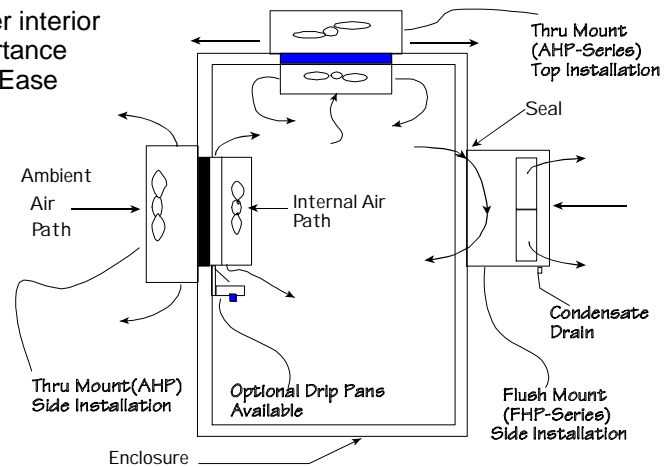

## Condensate Removal System:

All FHP-Series and AHP-1400 air conditioners contain a built-in condensate removal system. The condensate kit consists of a antifungal sponge with a condensate wick. PVC tubing is also provided for drainage. Drip pans are optional for thru mount units which must be evaluated on an individual basis. Equations defining a relationship between the cold side fin and enclosure temperatures are provided to assist in the evaluation.

## Top Mounting:

Though often the easiest location to mount it is often the most difficult to protect from condensation in this orientation due to the fin orientation, gravity and any susceptible components below. If a drip pan is employed by the end user use caution to place the pan far enough away from the internal fan to minimize the restriction of air flow. The pan should cover the fin ends as well as the fan area. When there is a choice, the vertical orientation is preferred by most users.

## Maintenance:

Since the technology is solid-state, there are no filters, compressors, or fluorocarbons to maintain. The only moving parts are the fans. It is recommended for harsh or dirty environments that the heat sinks be cleaned from time to time. This can be accomplished by directing compressed air over the external fins or on NEMA 4 versions by hosing the unit down. This will increase the overall life and performance of the system.

## Cautions:

Take care when mounting not to damage the seal between the hot and cold side sinks. Do not attempt to mount a unit to a warped surface or try to make the units mounting surface conform to an unflat surface. Do not pinch or damage any leads when mounting. Do not over tighten any installation screw, use reasonable force. Always mount with any condensate drain down. Do not compress the cold side between the hot side and any other surface. Do not obstruct the airflow on either side. When mounting consider the natural air flows of the enclosure. Connect power only after the installation is complete.

## Notes on condensation:

Condensation occurs at the cold side fins when the surface temperature goes below the dew point. To reduce or remove condensate, consider the following:

- Regulate the Fin Temperature above the Dewpoint.
- Keep Enclosure Closed and Sealed from Outside Humidity.
- Use Desiccant (Moisture absorbing Granules.)
- Employ Condensate Removal System/Drip Pans.

If you have any questions regarding your installation, Please feel free to contact our technical department for assistance at 773-342-4900.

# AHP-1800EP

# Air Conditioner

Air Cooled  
Thru Mount  
NEMA-12, 4X, Class I Div 2

120 VAC, 240 VAC Input  
Hazardous Locations

## FEATURES

- Compact, (18" L X 12.35" W X 9.69"D)
- Excels in high ambient temperatures
- Environmentally Safe
- Dual voltage versions available, consult factory.
- No compressor, fluorocarbons or filters
- Virtually maintenance-free operation
- Stainless steel exterior housing
- Versions to withstand corrosive environments, shock and vibration
- Mounts and operates in any orientation
- Groups A, B, C, D

## INCLUDES

- Adjustable temperature control
- Mounting gasket and hardware
- Power input line cord

## OPTIONS

- Other temperature settings for single set point controls



## SPECIFICATIONS

N  
E  
M  
A  
12  
  
C  
I  
D  
2  
  
N  
E  
M  
A  
4X  
  
C  
I  
D  
2

MODEL	PART NUMBER	PERFORMANCE RATING BTU/HR	VOLTAGE VAC 50/60 HZ	CURRENT AMPS.	WEIGHT LBS.(KG)	TEMP. CONTROL	OPERATING AMBIENT TEMPERATURE RANGE °C	OPERATING ENCLOSURE TEMPERATURE RANGE °C	AGENCY APPROVALS
AHP-1800EP	0-0180-0-002	1035-1180	120	8.0	46(21)	TC-6F	-40/+63	-10/+60	UL1604/UL1995/CSA22.2
AHP-1800EP	0-01F0-0-002	1035-1180	120	8.0	46(21)	85°F (30°C)	-40/+63	-10/+60	UL1604/UL1995/CSA22.2
AHP-1800EP-1	0-0170-0-004	1035-1180	120	8.0	46(21)	EXT*	-40/+63	-10/+60	UL1604/UL1995/CSA22.2
AHP-1800EPHC	0-0130-1-003	1035-1180	120	8.0	46(21)	TC-3F	-40/+63	-10/+60	UL1604/UL1995/CSA22.2
AHP-1800EPHC-1	0-0170-1-006	1035-1180	120	8.0	46(21)	EXT*	-40/+63	-10/+60	UL1604/UL1995/CSA22.2
AHP-1801EP	0-0181-0-002	1035-1180	120/240	8.0/5.0	46(21)	TC-6F	-40/+63	-10/+60	UL1604/UL1995/CSA22.2
AHP-1801EP	0-01F1-0-002	1035-1180	120/240	8.0/5.0	46(21)	85°F (30°C)	-40/+63	-10/+60	UL1604/UL1995/CSA22.2
AHP-1801EP-1	0-0171-0-002	1035-1180	120/240	8.0/5.0	46(21)	EXT*	-40/+63	-10/+60	UL1604/UL1995/CSA22.2
AHP-1801EPHC	0-0131-1-003	1035-1180	120/240	8.0/5.0	46(21)	TC-3F	-40/+63	-10/+60	UL1604/UL1995/CSA22.2
AHP-1801EPHC-1	0-0131-1-006	1035-1180	120/240	8.0/5.0	46(21)	EXT*	-40/+63	-10/+60	UL1604/UL1995/CSA22.2
AHP-1800XP	0-0180-2-002	1035-1180	120	8.0	47(21.4)	TC-6F	-40/+75	-10/+60	UL1604/UL1995/CSA22.2
AHP-1800XP	0-01F0-2-002	1035-1180	120	8.0	47(21.4)	85°F (30°C)	-40/+75	-10/+60	UL1604/UL1995/CSA22.2
AHP-1800XP-1	0-0170-2-004	1035-1180	120	8.0	47(21.4)	EXT*	-40/+75	-10/+60	UL1604/UL1995/CSA22.2
AHP-1800XPHC	0-0130-3-003	1035-1180	120	8.0	47(21.4)	TC-3F	-40/+75	-10/+60	UL1604/UL1995/CSA22.2
AHP-1800XPHC-1	0-0170-3-006	1035-1180	120	8.0	47(21.4)	EXT*	-40/+75	-10/+60	UL1604/UL1995/CSA22.2
AHP-1801XP	0-0181-2-002	1035-1180	120/240	8.0/5.0	47(21.4)	TC-6F	-40/+75	-10/+60	UL1604/UL1995/CSA22.2
AHP-1801XP	0-01F1-2-002	1035-1180	120/240	8.0/5.0	47(21.4)	85°F (30°C)	-40/+75	-10/+60	UL1604/UL1995/CSA22.2
AHP-1801XP-1	0-0171-2-005	1035-1180	120/240	8.0/5.0	47(21.4)	EXT*	-40/+75	-10/+60	UL1604/UL1995/CSA22.2
AHP-1801XPHC	0-0131-3-003	1035-1180	120/240	8.0/5.0	47(21.4)	TC-3F	-40/+75	-10/+60	UL1604/UL1995/CSA22.2
AHP-1801XPHC-1	0-0171-3-004	1035-1180	120/240	8.0/5.0	47(21.4)	EXT*	-40/+75	-10/+60	UL1604/UL1995/CSA22.2

\* Unit is set for 5-32 VDC external signal, relay(s) included

Consult factory for shock and vibration models

# AHP-1800EP

## PERFORMANCE CURVE

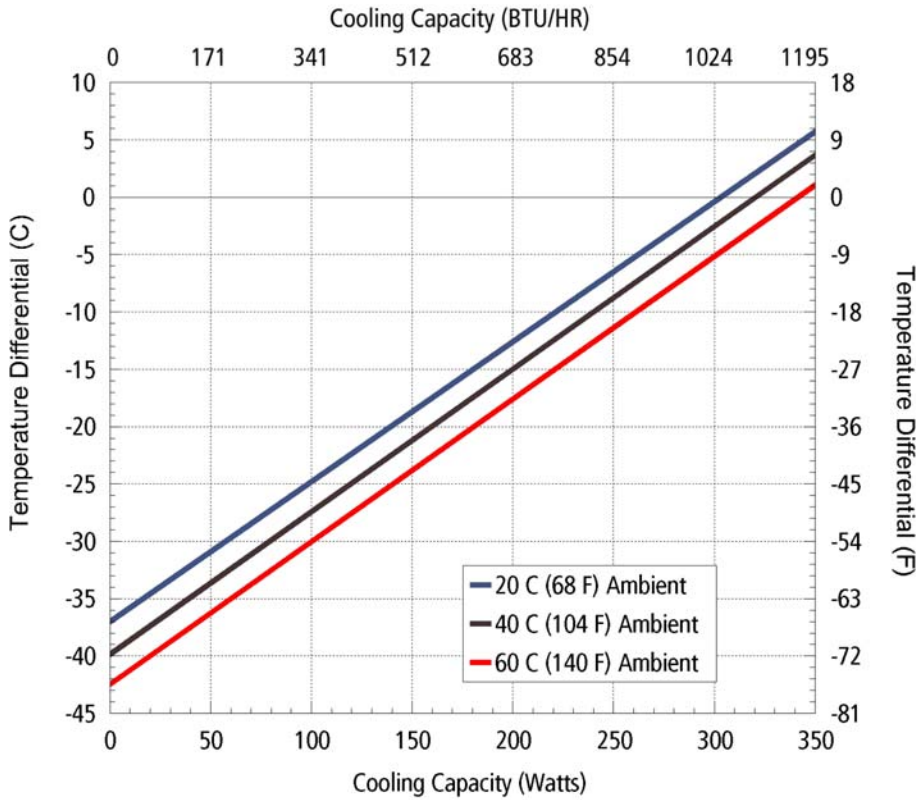

Equation of line: $y = \Delta T(^{\circ}C)$ $x = \text{Capacity (Watts)}$			
Ambient Temp	20°C	40°C	60°C
Enclosure Air	$y = .122x - 37.0$	$y = .122x - 39.7$	$y = .122x - 42.3$
Cold Sink	$y = .09x - 37.0$	$y = .09x - 39.7$	$y = .09x - 42.3$

## MOUNTING STYLE

Thru Mount

## ENVIRONMENTS SERVED

Class I Div 2 NEMA-12 IP 52  
 Class I Div 2 NEMA-4X IP 56

## RATING (TRADITIONAL)

1100 BTU/hr @ 0 °F ΔT  
 1420 BTU/hr @ +20 °F ΔT \*

## RATING (DIN 3168)

322 Watts L35 L35  
 210 Watts L35 L50

\* See page 10

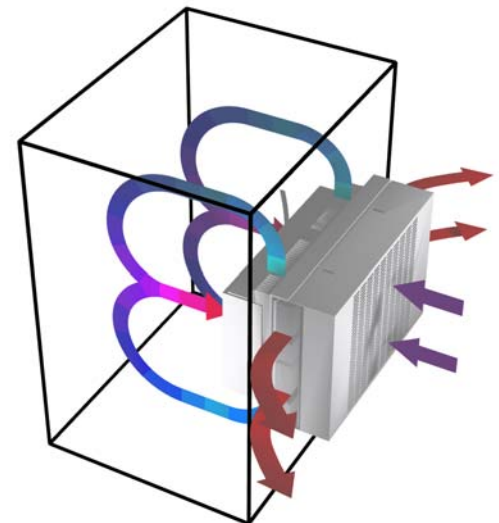

Air Flow Pattern

## DIMENSIONS

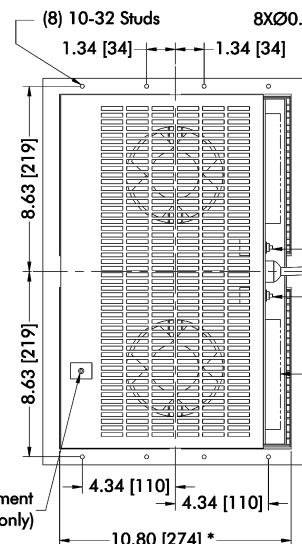
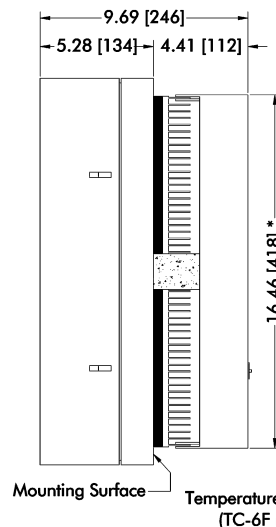
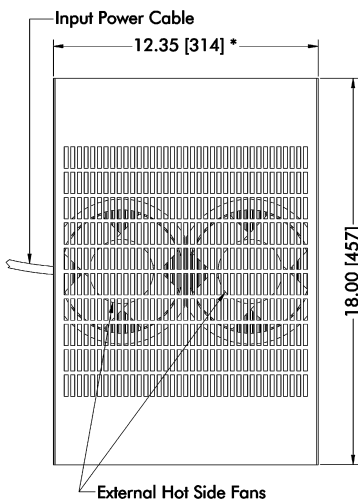

## MOUNTING CUTOUT DIMENSIONS

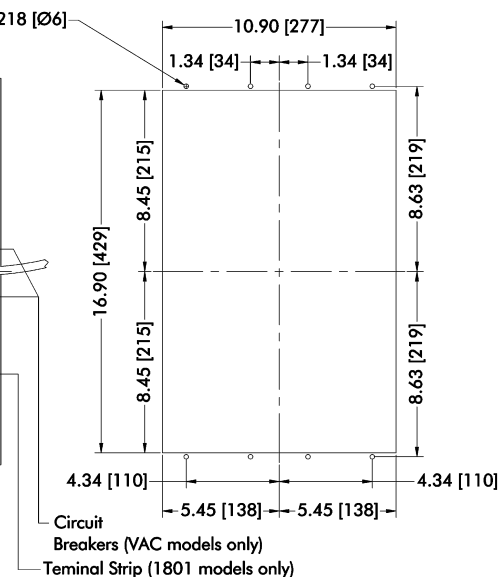

\* Dimension does not include hardware and sealant.  
 Mounting hardware and gasket included but not shown.  
 Dimensions: Inches [Millimeters]

LTR	DESCRIPTION	DATE	APPROVED
A	ADD METRIC DIMENSIONS	07/23/90	J.N
B	REVISED TITLE	05/13/90	J.N
C	CORRECTED 1.34 TO 1.34 (44) TO (34)	04/10/92	J.N

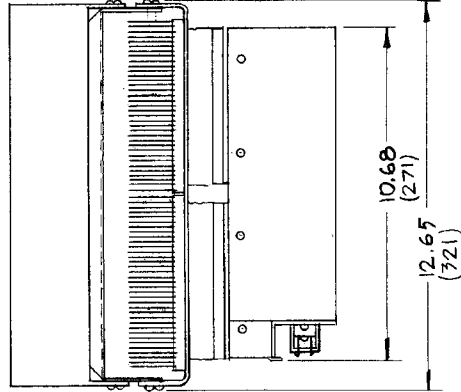

NOTE: DIMENSIONS IN INCHES (MILLIMETERS)

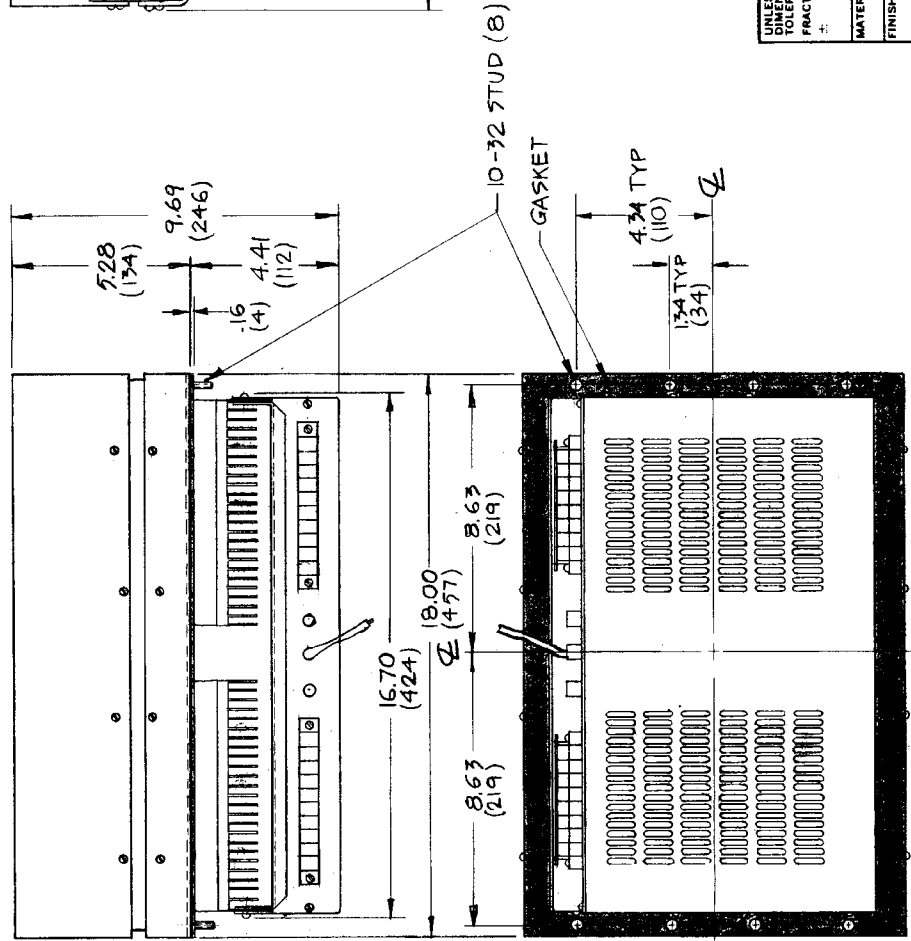

UNLESS OTHERWISE SPECIFIED DIMENSIONS ARE IN INCHES TOLERANCES ARE:	
+	.XX ±
+	.XXX ±
MATERIAL	
FINISH	
APPROVALS	DATE
DRAWN J.N.	1/23/90
CHECKED	

AHP 180I/180IX ASSEMBLY	
SIZE	DRAWING NO.
B	1800-B-A18
SCALE 1/4	SHEET 12 OF 21

- D INDICATES BLUE RING TERMINAL
- INDICATES SOLDER CONNECTION
- ◆ INDICATES RED RING TERMINAL
- INDICATES SMALL RED RING TERMINAL
- ⊔ INDICATES SMALL BLUE RING TERMINAL

- INDICATES 18 AWG WIRE
- INDICATES 20 AWG WIRE
- ⊖ INDICATES PLENUM CABLE WIRE
- INDICATES 16 AWG WIRE

- ◇ INDICATES AMP 321519 CLOSED END SPLICE
- ◆ INDICATES AMP 55843-1 CLOSED END SPLICE

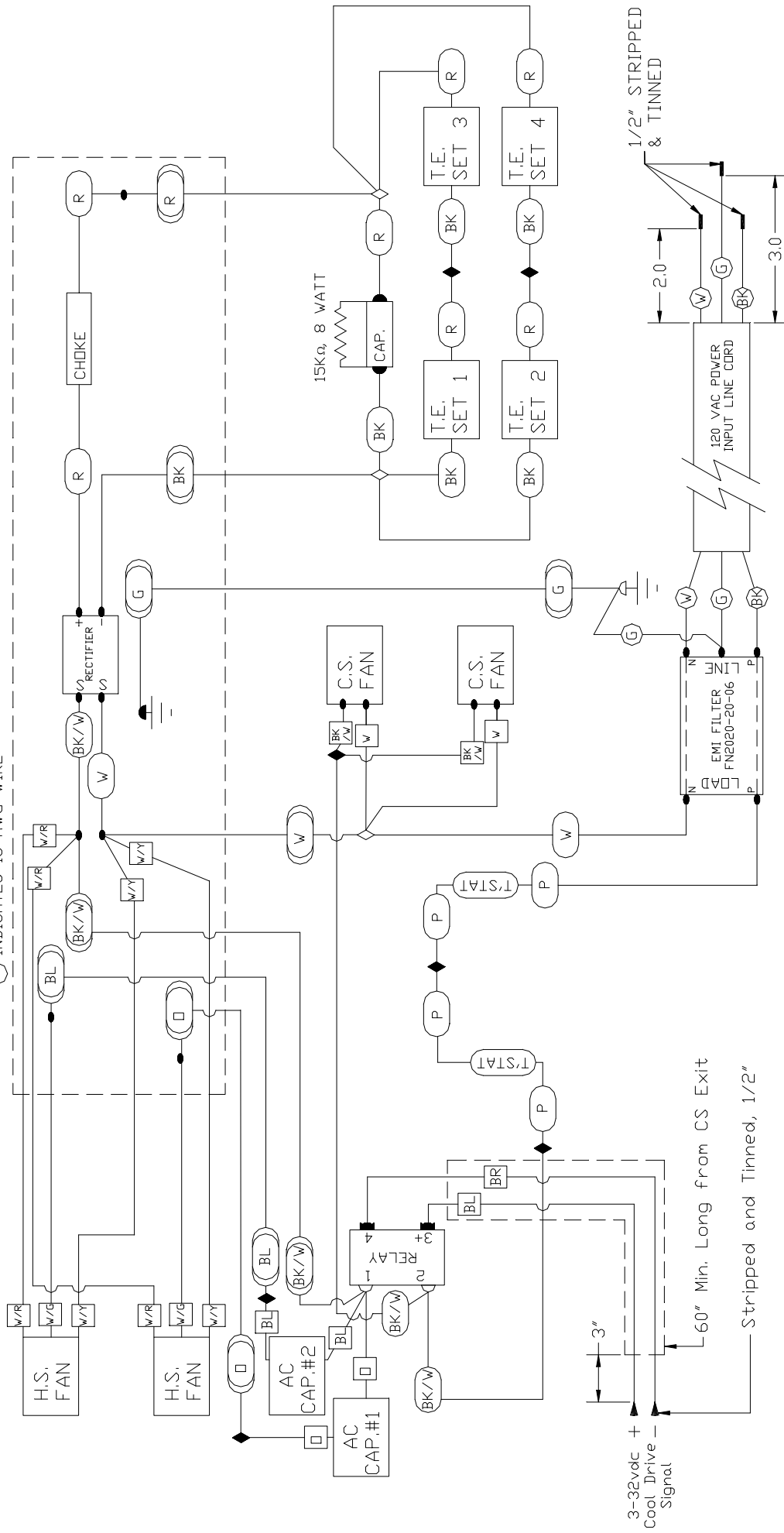

3-32vdc +  
Cool Drive -  
Signal

60" Min. Long from CS Exit  
Stripped and Tinned, 1/2"

<b>INFORMATION DISCLOSED HEREIN IS THE CONFIDENTIAL PROPERTY OF TECA CORP. RECIPIENT SHALL NOT USE THE INFORMATION IN ANY UNAUTHORIZED MANNER.</b>		UNLESS OTHERWISE SPECIFIED DIMENSIONS ARE IN INCHES TOLERANCES ARE: DECIMALS    +/- XX +/- FRACTION    +/- XXX +/- MATERIAL:	
<b>FINISH:</b>		<b>DATE:</b> 03/07/02	
<b>APPROVED:</b> AA		<b>DRAWING #:</b> AA	
<b>DESCRIPTION:</b> A Added EMI filter.		<b>SCALE:</b> 1800-A-E109	
<b>REV:</b>		<b>MASTER:</b> MASTER	
<b>DATE:</b> 05/23/2011		<b>REV LEVEL:</b> A	
<b>APPROVED:</b>		<b>SHEET:</b>	

**THERMOELECTRIC COOLING AMERICA CORP.**

AHP-1800XP-1  
WIRING DIAGRAM

# Mounting, Montage, Montaggio

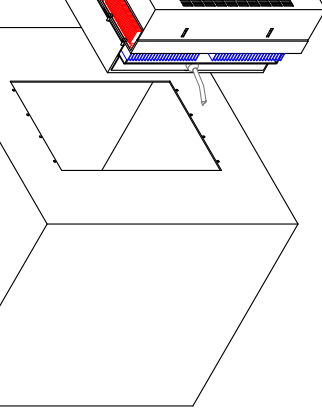
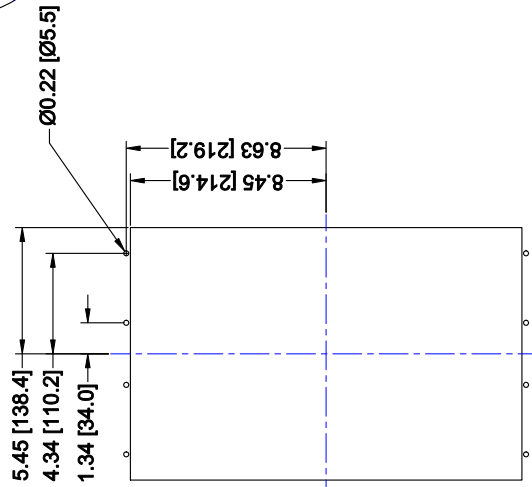
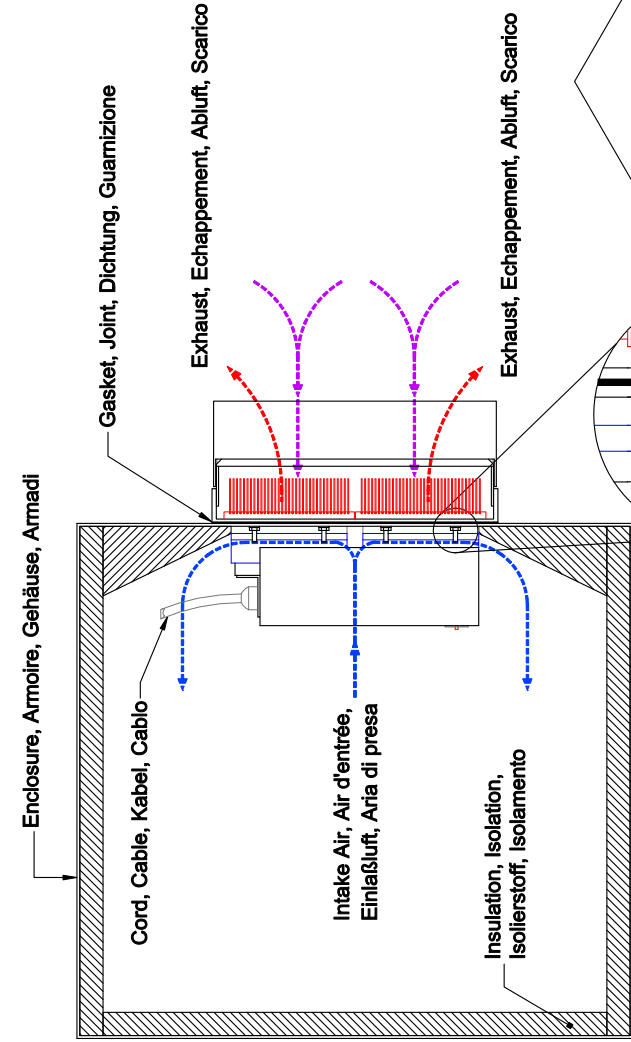
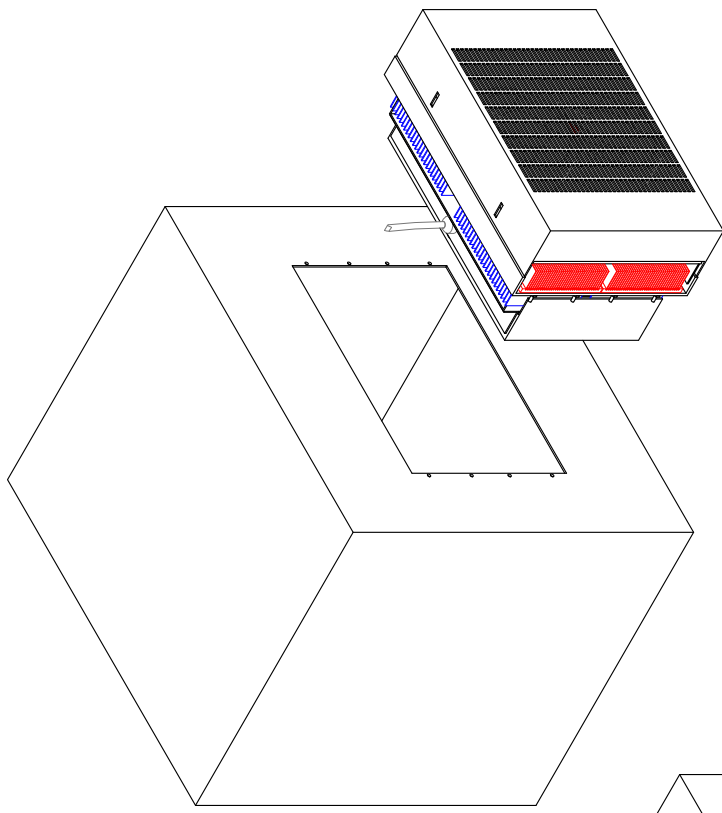

Alternate, Alternative, Alternativa

Warning - This equipment is suitable for use in Class I Division 2, Groups A, B, C, D or Non-Hazardous locations only.  
 Warning - Explosion Hazard - Substitution of components may impair suitability for Class I, Division 2.  
 Avertissement - Risque D'Explosion - La substitution de composants peut rendre ce matériel inacceptable pour les emplacements de Classe I, Division 2.  
 Achtung - Explosionsgefahr - Das Austauschen von Komponenten kann die Eignung für Klasse I, Division 2 beeinträchtigen.  
 Attenzione - Pericolo di esplosione - La sostituzione di componenti può compromettere per la classe I, Divisione 2.

English, Français, Deutsch, Italiano  
 Dimensions: inches [Millimeters]

UNLESS OTHERWISE SPECIFIED DIMENSIONS ARE IN INCHES  
 TOLERANCES ARE:  
 DECIMALS .XX +/- ANGLE +/-  
 FRACTION .XXX +/- FRACTION +/-  
 FINISH: MATERIAL:

**THERMOELECTRIC COOLING AMERICA CORP.**  
**AHP-1800EP / AHP-1800XP SERIES**  
**TYPICAL FIELD MOUNTING**

REV	DESCRIPTION	Date	APPROVED
A	Changed AHP-1800P to AHP-1800EP in title block.	09/01/2011	AA

DRAWN BY: AA	DRAWING #	REV LEVEL
DATE: 05/23/2011	1800-A-F52	A
D8090	SCALE	SHEET
		MASTER: MASTER



ThermoElectric Cooling America Corporation  
4048 W. Schubert Avenue • Chicago, IL (U.S.A.) 60639  
Ph: 773/342-4900 Fx: 773/342-0191  
teca@thermoelectric.com www.thermoelectric.com

## DECLARATION OF CONFORMITY

### TYPE OF EQUIPMENT

Electrical Heat Pump, Air Conditioner  
Solid State Cooling Devices

### MODEL NUMBERS

Model nos. AHP followed by -1200XP, or -1200XPM, or 1200EP, or -1201XP, or -1201XPM or -1201EP; may be followed by HC may be followed by -1 or W/TC followed by -3F or -6F.

Model nos. AHP followed by 1800XP or 1800EP; may be followed by HC; may be followed by -1, or -2, or W/TC followed by 3F or 6F.

Model nos. AHP followed by -1801XP or -1801EP; may be followed by HC; may be followed by -1 or -2, or W/TC followed by 3F or 6F.

Model no. AHP followed by -1802XP or 1802EP may be followed by HC, may be followed by -1, or -2, or W/TC followed by 3F or 6F.

### YEAR OF MANUFACTURE

Refer to the first two digits of the serial number on the manufacturers ID label

### MANUFACTURER

TECA Corporation  
4048 W. Schubert Avenue  
Chicago, IL 60639  
U.S.A.

### APPLIED STANDARDS

- Standard for Electrical Equipment for Use in Class I and Class II, Division 2 and Class III Hazardous (Classified) Locations (UL 1604 - 3rd Edition 10/06/1995)  
[Note: For use in Class I, Division 2 Locations Only]
- Standard for Non-Incendive Electrical Equipment for Use in Class I, Division 2 Hazardous Locations; Industrial Products; General Instruction No. 1 (CSA C22.2 No. 213-M1987 Ed.1 R1992)
- Standard for Safety of Heating and Cooling Equipment (UL 1995 / CSA C22.2.2 No. 236-05 - 3rd Edition, dated: February 18, 2005)

### TESTING AGENCY

ITS Intertek Testing Services ETL SEMKO



### REPORT No.

551722

VP of Engineering  
Andy Brecklin

May 26, 2011

## LIMITED WARRANTY

In the event a defect in material or workmanship is discovered in any of TECA's products within one year after the date they are delivered to Buyer, and if: (a) TECA is notified of the defect in writing by certified mail within 14 days of the date of discovery; (b) TECA may then either, at its sole discretion, inspect the product at Buyer's location, or require that the product be made available at Buyer's expense at TECA's premises for TECA's inspection within 14 days of the date of notification; and (c ) the products are defective and the defects result from faulty materials and/or workmanship and not in any way from accident, misuse, misapplication, mishandling, modification, or alteration by the Buyer or the shipper, then TECA shall, at its sole option, repair or exchange defective products free of charge to Buyer, or credit to buyer the price of the defective products. ALL OTHER WARRANTIES, EXPRESS OR IMPLIED, ARE EXCLUDED, INCLUDING BUT NOT LIMITED TO THE IMPLIED WARRANTIES OF MERCHANTABILITY AND FITNESS FOR A PARTICULAR PURPOSE. IN NO EVENT SHALL TECA BE LIABLE FOR ANY CLAIM BASED UPON BREACH OF EXPRESS OR IMPLIED WARRANTY OR ANY OTHER DAMAGES WHETHER SPECIAL, INDIRECT, INCIDENTAL, CONSEQUENTIAL, LOST PROFITS, BUSINESS INTERRUPTION, OR LOSS OF BUSINESS OR CUSTOMER RELATIONSHIPS.

## RETURNED GOODS, RESTOCKING CHARGES

In order to return merchandise for any reason ( repair, replacement, or credit) a return authorization number must be issued by TECA. New merchandise may not be returned for credit beyond 60 days from shipment. Charges for incidental or other damages may also be made. All returned goods must be sent freight prepaid. A restocking charge of 15% will apply. On special equipment and custom modified equipment orders, additional incremental cancellation charges may be made.