

Product Information Packet

Model AHP-1200XE

NEMA-4, Solid State Air Conditioner, 24 VDC

Set for Remote Temperature Control

Part #0-3055-4-000

Thank you for your purchase. Information has been enclosed regarding the installation, specifications, and wiring of your solid-state assembly. Please read and follow all instructions carefully before installation. Only qualified technicians should install this equipment.

If you have any questions regarding your equipment, please do not hesitate to call us at 773-342-4900, and we will be happy to assist you. We are open from 8:30 am-5:00 pm Central Time.

Included in this packet you will find:

Installation Notes for Air Conditioners

Product Literature and Specifications

Assembly Drawing # 1200-B-A13

Wiring Drawing # SK060956

Installation Drawing # 1200-A-F57

Warranty Information

The logo for Teca, featuring the word "teca" in a bold, lowercase, sans-serif font. The letter "t" is stylized with a vertical line extending downwards from its base.

ThermoElectric Cooling America Corporation
4048 W. Schubert Avenue • Chicago, IL (U.S.A.) 60639
Ph: 773/342-4900 Fx: 773/342-0191
sales@thermoelectric.com www.thermoelectric.com

Important Installation Notes for Air Conditioners

Mounting Styles: Both 'thru mount' and 'flush mount' units can be positioned in any orientation and on any enclosure surface. It is important to consider interior air flow patterns when determining the mounting location. Also of importance is an unrestricted flow of ambient air thru the hot side heat exchanger. Ease of access and inspection must be considered for those applications in particularly severe environments which may require occasional maintenance.

Vertical (Side/Front/Back) Mounting:

Vertical mounting refers to the vertical direction of the cold side or interior fins and is recommended for applications with high humidity, poor and incomplete cabinet seals or any condition which may cause the cold side fins to be maintained at temperatures below the dew point for long periods of time allowing for the formation of condensation. The vertical fin direction provides a drip path whereupon condensation can be collected via a moisture removal system (standard on FHP-units) or a drip pan positioned below the cold side fins. Drip pans are optional for thru mount units.

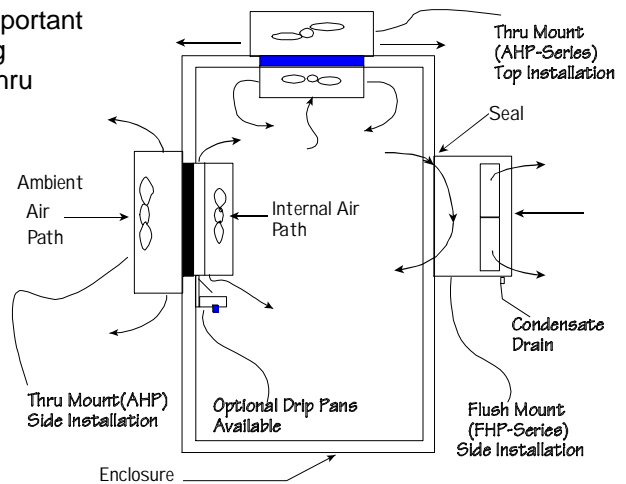

Condensate Removal System:

All FHP-Series and AHP-1400 air conditioners contain a built-in condensate removal system. The condensate kit consists of a antifungal sponge with a condensate wick. PVC tubing is also provided for drainage. Drip pans are optional for thru mount units which must be evaluated on an individual basis. Equations defining a relationship between the cold side fin and enclosure temperatures are provided to assist in the evaluation.

Top Mounting:

Though often the easiest location to mount it is often the most difficult to protect from condensation in this orientation due to the fin orientation, gravity and any susceptible components below. If a drip pan is employed by the end user use caution to place the pan far enough away from the internal fan to minimize the restriction of air flow. The pan should cover the fin ends as well as the fan area. When there is a choice, the vertical orientation is preferred by most users.

Maintenance:

Since the technology is solid-state, there are no filters, compressors, or fluorocarbons to maintain. The only moving parts are the fans. It is recommended for harsh or dirty environments that the heat sinks be cleaned from time to time. This can be accomplished by directing compressed air over the external fins or on NEMA 4 versions by hosing the unit down. This will increase the overall life and performance of the system.

Cautions:

Take care when mounting not to damage the seal between the hot and cold side sinks. Do not attempt to mount a unit to a warped surface or try to make the units mounting surface conform to an unflat surface. Do not pinch or damage any leads when mounting. Do not over tighten any installation screw, use reasonable force. Always mount with any condensate drain down. Do not compress the cold side between the hot side and any other surface. Do not obstruct the airflow on either side. When mounting consider the natural air flows of the enclosure. Connect power only after the installation is complete.

Notes on condensation:

Condensation occurs at the cold side fins when the surface temperature goes below the dew point. To reduce or remove condensate, consider the following:

- Regulate the Fin Temperature above the Dewpoint.
- Keep Enclosure Closed and Sealed from Outside Humidity.
- Use Desiccant (Moisture absorbing Granules.)
- Employ Condensate Removal System/Drip Pans.

If you have any questions regarding your installation, Please feel free to contact our technical department for assistance at 773-342-4900.



AHP-1200

Air Conditioner

Air Cooled
Through Mounted
NEMA-12, 4,4X

24 VDC Input
High Efficiency
530 BTU/HR



FEATURES

- High capacity thermoelectric design
- Lower profile intrusion into enclosure
- Closed loop design
- Condensate control and evaporation system
- Compact
- Increased efficiency at higher ambients by as much as 12%
- Virtually maintenance free
- No compressor
- Environmentally friendly and safe
- Stainless Steel exterior housing
- Mounts and operates in any orientation
- Integral temperature controller
- Operating ambient temperature range -40/+70 °C
- Operating enclosure temperature range -10/+60 °C
- Easy to use Pivot Clean feature
- Weight 18 LBS.
- Agency approvals: UL 1995, CSA 22.2, CE

POWER INPUTS

Voltage	24 VDC
Current, Active	9.0 AMPS
Current, ECO-Mode	0.9 AMPS

PERFORMANCE RATINGS

Cooling (Traditional)	530 BTU/HR
Cooling (Din 3168)	154 WATTS
Cooling COP (at L35 L35)	0.71
Heating (Traditional)	> 736 BTU/HR
Heating (Din 3168)	> 216 WATTS
Heating COP	> 1.0

INCLUDES

- Temperature controller
- Mounting gasket
- Mounting hardware
- Power input leads

CONFIGURATIONS

MODEL	PART NUMBER	NOTES	TEMPERATURE CONTROL	ENVIRONMENT
AHP-1200	0-3095-0-000	Cool only	None	NEMA-12, IP 52
AHP-1200	0-3085-0-000	Cool only	TC-6F	NEMA-12, IP 52
AHP-1200	0-30F5-0-000	Cool only	TC-1F	NEMA-12, IP 52
AHP-1200	0-3055-0-000	Cool only	EXT*	NEMA-12, IP 52
AHP-1200HC	0-3035-1-000	Heat/Cool	TC-3F	NEMA-12, IP 52
AHP-1200HC	0-3015-1-000	Heat/Cool	TC-7F	NEMA-12, IP 52
AHP-1200HC	0-3055-1-000	Heat/Cool	EXT*	NEMA-12, IP 52
AHP-1200XE	0-3095-4-000	Cool only	None	NEMA-4, IP 56
AHP-1200XE	0-3085-4-000	Cool only	TC-6F	NEMA-4, IP 56
AHP-1200XE	0-30F5-4-000	Cool only	TC-1F	NEMA-4, IP 56
AHP-1200XE	0-3055-4-000	Cool only	EXT*	NEMA-4, IP 56
AHP-1200XEHC	0-3035-5-000	Heat/Cool	TC-3F	NEMA-4, IP 56
AHP-1200XEHC	0-3015-5-000	Heat/Cool	TC-7F	NEMA-4, IP 56
AHP-1200XEHC	0-3055-5-000	Heat/Cool	EXT*	NEMA-4, IP 56
AHP-1200XEHC†	0-30L5-5-000	Heat/Cool	TC-5300D	NEMA-4, IP 56

† Precise temperature control model

MODEL	PART NUMBER	NOTES	TEMPERATURE CONTROL	ENVIRONMENT
AHP-1200X	0-3095-2-000	Cool only	None	NEMA-4X, IP 56
AHP-1200X	0-3085-2-000	Cool only	TC-6F	NEMA-4X, IP 56
AHP-1200X	0-30F5-2-000	Cool only	TC-1F	NEMA-4X, IP 56
AHP-1200X	0-3055-2-000	Cool only	EXT*	NEMA-4X, IP 56
AHP-1200XHC	0-3035-3-000	Heat/Cool	TC-3F	NEMA-4X, IP 56
AHP-1200XHC	0-3015-3-000	Heat/Cool	TC-7F	NEMA-4X, IP 56
AHP-1200XHC	0-3055-3-000	Heat/Cool	EXT*	NEMA-4X, IP 56
AHP-1200XM	0-3095-2-041	Cool only	None	NEMA-4X, IP 56
AHP-1200XM	0-3085-2-034	Cool only	TC-6F	NEMA-4X, IP 56
AHP-1200XM	0-30F5-2-035	Cool only	TC-1F	NEMA-4X, IP 56
AHP-1200XM	0-3055-2-036	Cool only	EXT*	NEMA-4X, IP 56
AHP-1200XMHC	0-3035-3-037	Heat/Cool	TC-3F	NEMA-4X, IP 56
AHP-1200XMHC	0-3015-3-040	Heat/Cool	TC-7F	NEMA-4X, IP 56
AHP-1200XMHC	0-3055-3-038	Heat/Cool	EXT*	NEMA-4X, IP 56
AHP-1200HC†	0-30L5-1-000	Heat/Cool	TC-5300D	NEMA-12, IP 52

* Unit is set for 5-32 VDC external signal, relay(s) included

CONTROL TEMPERATURES

Temp. Control	Active Heat °C	ECO-Mode °C	Active Cool °C
TC-1F	-	-	35
TC-6F	-	-	25 or 35
TC-3F	10	-	35
TC-7F	10	25	35

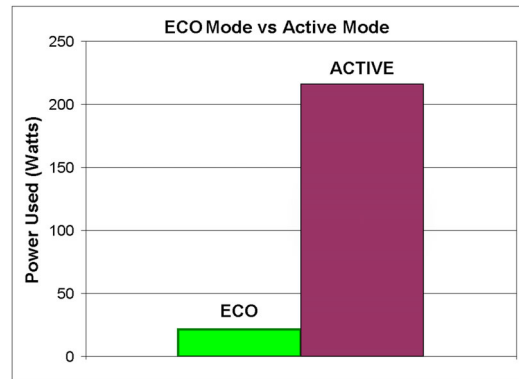

LTR	DESCRIPTION	DATE	APPROVED
A	CHANGED NUMBER OF STUDS AND DRAWING NUMBER	12-10-88	T. Z.
B	ADD METRIC DIMENSIONS	03.23.90	I.N.

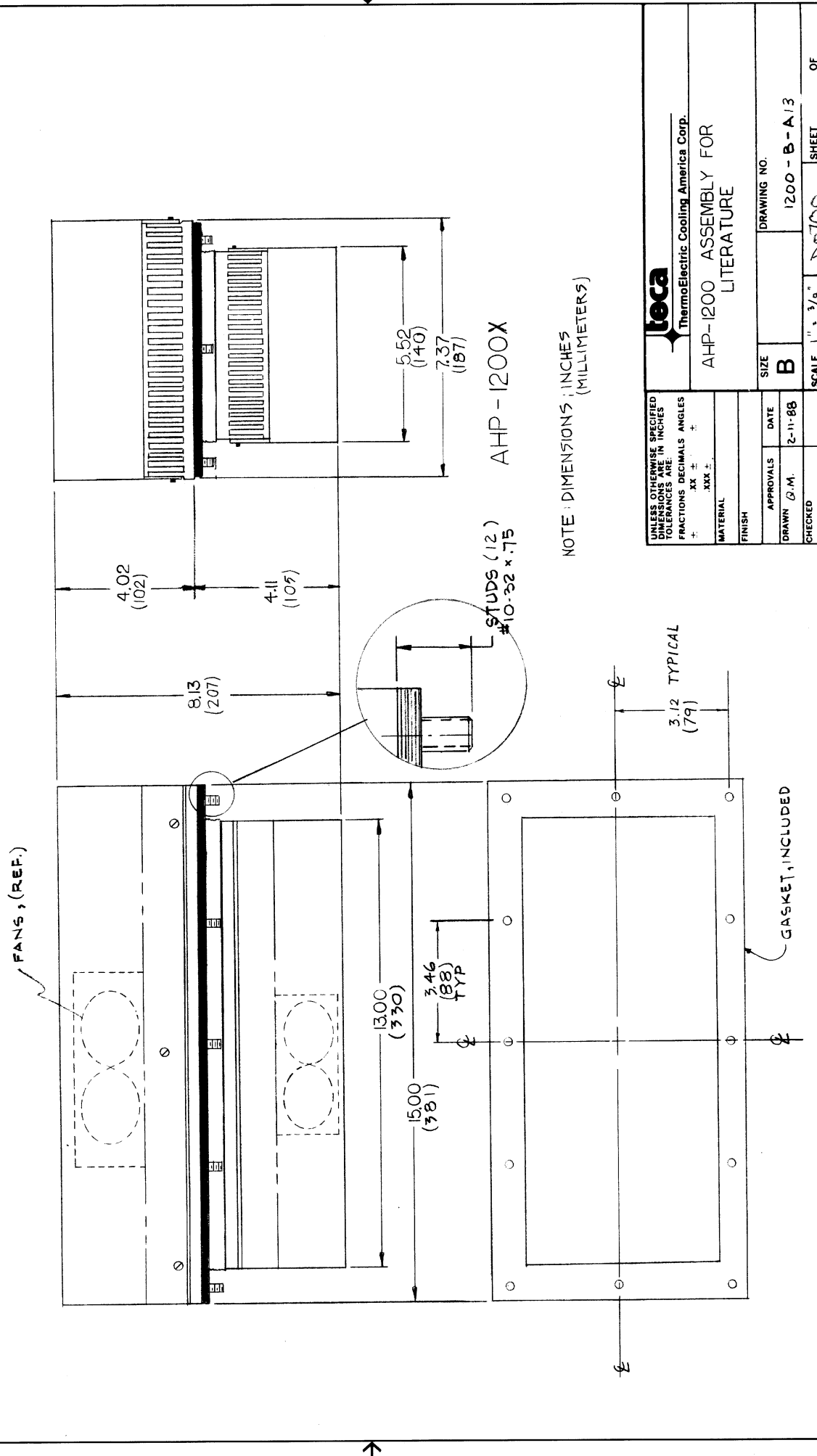

 ThermoElectric Cooling America Corp.	
AHP-1200 ASSEMBLY FOR LITERATURE	
UNLESS OTHERWISE SPECIFIED DIMENSIONS ARE IN INCHES TOLERANCES ARE:	FRACTIONS DECIMALS ANGLES
± .005 ± .010 ± .015	± .001 ± .002 ± .005
MATERIAL	FINISH
APPROVALS	DATE
DRAWN G.M.	2-11-88
CHECKED	SIZE
B	DRAWING NO.
SCALE 1" = 3/8"	1200 - B - A/3
D0700	SHEET
OF	OF

REV	DESCRIPTION	Date	APPROVED

Cold Side TE Hot Side

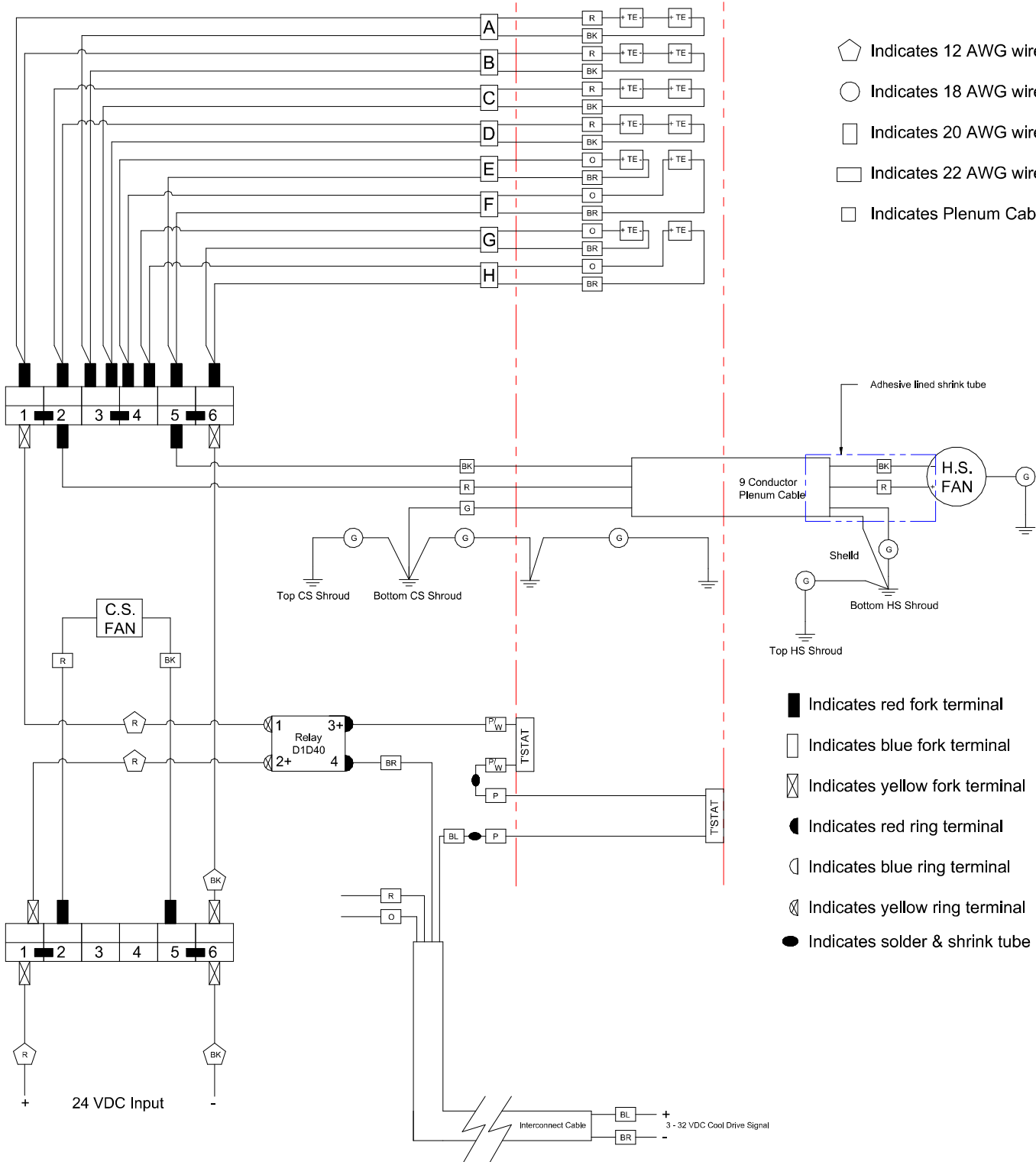

- ⬡ Indicates 12 AWG wire
- Indicates 18 AWG wire
- Indicates 20 AWG wire
- ▭ Indicates 22 AWG wire
- ◻ Indicates Plenum Cable wire

- Indicates red fork terminal
- Indicates blue fork terminal
- ⊗ Indicates yellow fork terminal
- Indicates red ring terminal
- Indicates blue ring terminal
- ⊗ Indicates yellow ring terminal
- Indicates solder & shrink tube connection

INFORMATION DISCLOSED HEREIN IS THE CONFIDENTIAL PROPERTY OF TECA CORP. RECIPIENT SHALL NOT USE THE INFORMATION IN ANY UNAUTHORIZED MANNER.	UNLESS OTHERWISE SPECIFIED DIMENSIONS ARE IN INCHES TOLERANCES ARE:		THERMOELECTRIC COOLING AMERICA CORP.		
	DECIMALS .XX +/- .XXX +/-	ANGLE + / - FRACTION + / -	AHP-1200XE 24 VDC SET FOR REMOTE CONTROL WIRING DIAGRAM		
FINISH:	MATERIAL:	DRAWN BY: AA	DRAWING # SK060956		SHEET
		DATE: 09/20/06	SCALE	MASTER: SK060942	
		D6759			

REV	DESCRIPTION	Date	APPROVED

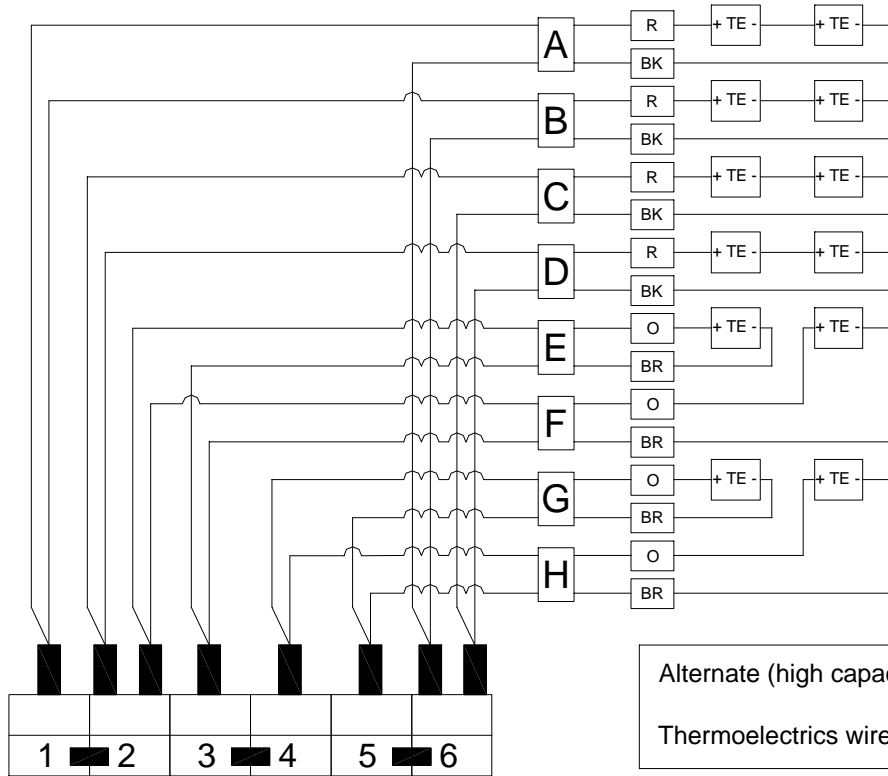

Alternate (high capacity) TE wiring:
Thermoelectrics wired for 12 VDC/TE.

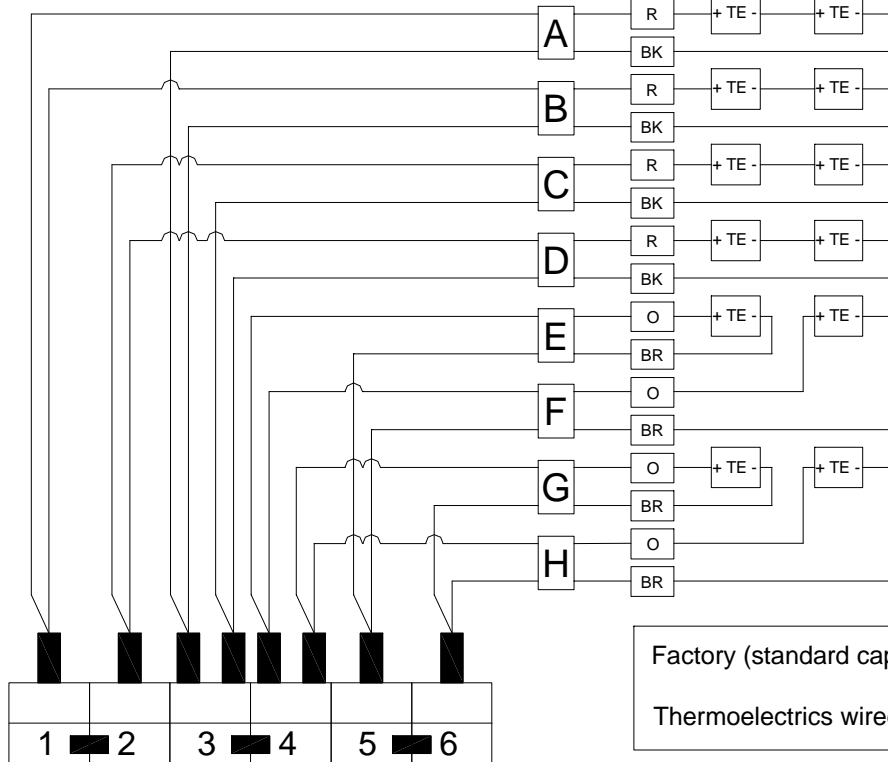

Factory (standard capacity) TE wiring:
Thermoelectrics wired for 8 VDC/TE.

INFORMATION DISCLOSED HEREIN IS THE CONFIDENTIAL PROPERTY OF TECA CORP. RECIPIENT SHALL NOT USE THE INFORMATION IN ANY UNAUTHORIZED MANNER. FINISH:	UNLESS OTHERWISE SPECIFIED DIMENSIONS ARE IN INCHES TOLERANCES ARE:	THERMOELECTRIC COOLING AMERICA CORP.								
	<table border="1"> <tr> <th>DECIMALS</th> <th>ANGLE</th> </tr> <tr> <td>.XX +/-</td> <td>+/-</td> </tr> <tr> <td>.XXX +/-</td> <td>FRACTION +/-</td> </tr> </table>	DECIMALS	ANGLE	.XX +/-	+/-	.XXX +/-	FRACTION +/-	AHP-1200 DC SERIES STANDARD & ALTERNATE TE WIRING		
	DECIMALS	ANGLE								
	.XX +/-	+/-								
.XXX +/-	FRACTION +/-									
MATERIAL:	DRAWN BY: AA DATE: 01/15/07 D7050	DRAWING # SK080114 SCALE	REV LEVEL SHEET							
		MASTER: SK060942								

Mounting, Monture, Montage, Montaggio

Enclosure, Armoire, Gehäuse, Armadi

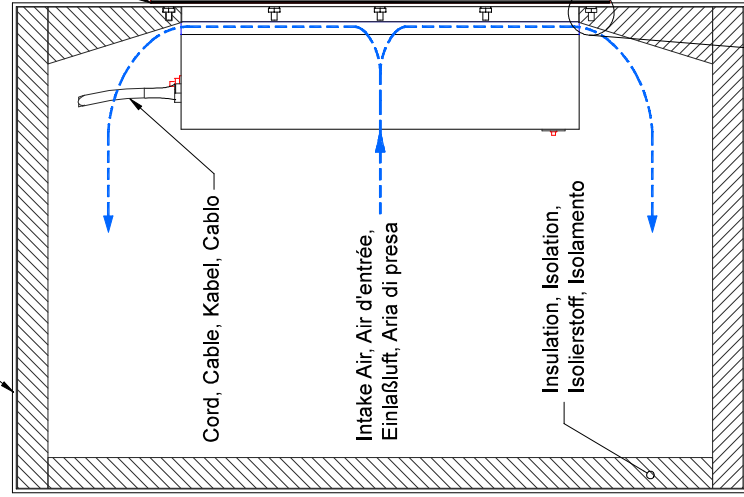

Gasket, Joint, Dichtung, Guarnizione

Exhaust, Echappement, Abluft, Scarico

Cord, Cable, Kabel, Cablo

Intake Air, Air d'entrée,
Einlaßluft, Aria di presa

Insulation, Isolation,
Isolierstoff, Isolamento

Exhaust, Echappement, Abluft, Scarico

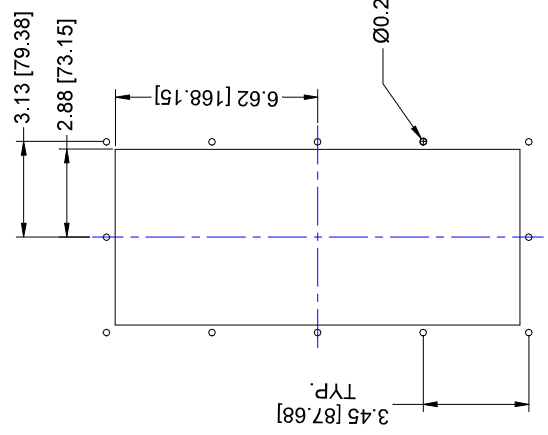
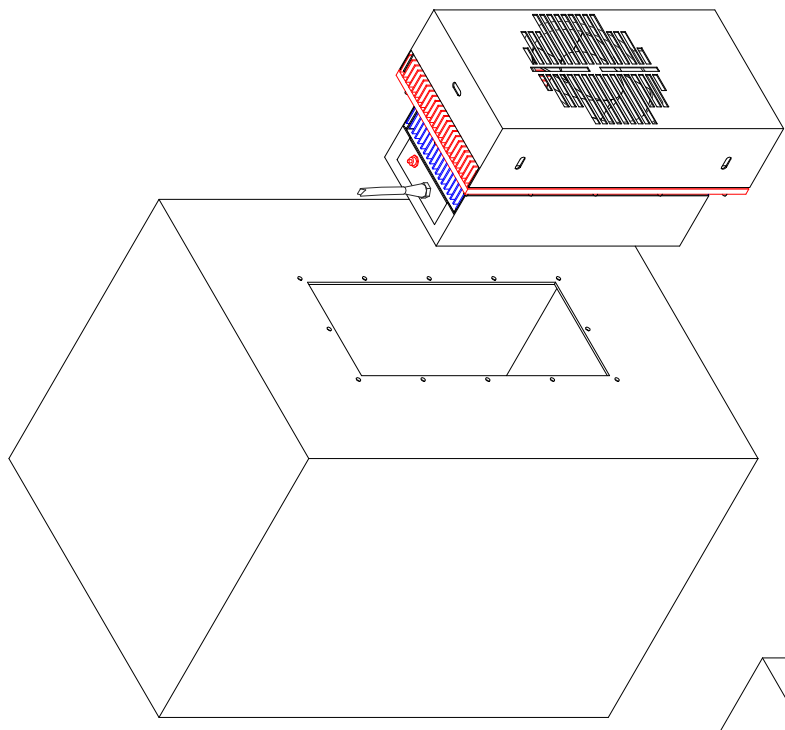
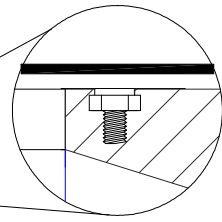

Alternate, Alternative, Alternativa

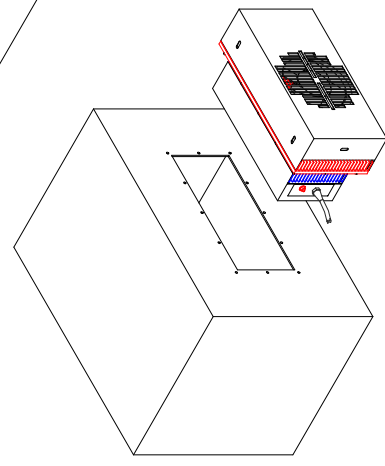

English, Français, Deutsch, Italiano
Dimensions: Inches [Millimeters]

INFORMATION DISCLOSED
HEREIN IS THE
CONFIDENTIAL PROPERTY
OF TECA CORP. RECIPIENT
SHALL NOT USE THE
INFORMATION IN ANY
UNAUTHORIZED MANNER.
FINISH:

DECIMALS	ANGLE
.XX +/-	+/-
.XXX +/-	FRACTION
	+/-

MATERIAL:

UNLESS OTHERWISE SPECIFIED
DIMENSIONS ARE IN INCHES
TOLERANCES ARE:

THERMOELECTRIC COOLING AMERICA CORP.
AHP-1200 SERIES
TYPICAL FIELD MOUNTING

REV	DESCRIPTION	Date	APPROVED
DRAWN BY:	AA	DRAWING #	1200-A-F57
DATE:	05/21/03	SCALE	MASTER: MASTER
			REV LEVEL
			SHEET

LIMITED WARRANTY

In the event a defect in material or workmanship is discovered in any of TECA's products within one year after the date they are delivered to Buyer, and if: (a) TECA is notified of the defect in writing by certified mail within 14 days of the date of discovery; (b) TECA may then either, at its sole discretion, inspect the product at Buyer's location, or require that the product be made available at Buyer's expense at TECA's premises for TECA's inspection within 14 days of the date of notification; and (c) the products are defective and the defects result from faulty materials and/or workmanship and not in any way from accident, misuse, misapplication, mishandling, modification, or alteration by the Buyer or the shipper, then TECA shall, at its sole option, repair or exchange defective products free of charge to Buyer, or credit to buyer the price of the defective products. ALL OTHER WARRANTIES, EXPRESS OR IMPLIED, ARE EXCLUDED, INCLUDING BUT NOT LIMITED TO THE IMPLIED WARRANTIES OF MERCHANTABILITY AND FITNESS FOR A PARTICULAR PURPOSE. IN NO EVENT SHALL TECA BE LIABLE FOR ANY CLAIM BASED UPON BREACH OF EXPRESS OR IMPLIED WARRANTY OR ANY OTHER DAMAGES WHETHER SPECIAL, INDIRECT, INCIDENTAL, CONSEQUENTIAL, LOST PROFITS, BUSINESS INTERRUPTION, OR LOSS OF BUSINESS OR CUSTOMER RELATIONSHIPS.

RETURNED GOODS, RESTOCKING CHARGES

In order to return merchandise for any reason (repair, replacement, or credit) a return authorization number must be issued by TECA. New merchandise may not be returned for credit beyond 60 days from shipment. Charges for incidental or other damages may also be made. All returned goods must be sent freight prepaid. A restocking charge of 15% will apply. On special equipment and custom modified equipment orders, additional incremental cancellation charges may be made.