

Product Information Packet

Model AHP-1801XHC

Solid State, NEMA 4X, Heat/Cool Air Conditioner

with TC-3F Temperature Control

Part #0-0131-3-000

Thank you for your purchase. Information has been enclosed regarding the installation, specifications, and wiring of your solid-state assembly. Please read and follow all instructions carefully before installation. Only qualified technicians should install this equipment.

If you have any questions regarding your equipment, please do not hesitate to call us at 773-342-4900, and we will be happy to assist you. We are open from 8:00 am-4:30 pm Central Time.

Included in this packet you will find:

Installation Notes for Air Conditioners

Product Literature and Specifications

Assembly Drawing # 1800-B-A18

Wiring Drawing # 1800-B-E13

Installation Drawing # 1800-A-F49

Temperature Control Information

Warranty Information

The logo for Teca, featuring the word "teca" in a bold, lowercase, sans-serif font. The letter "t" is stylized with a vertical line extending upwards from its stem.

ThermoElectric Cooling America Corporation
4048 W. Schubert Avenue • Chicago, IL (U.S.A.) 60639
Ph: 773/342-4900 Fx: 773/342-0191
sales@thermoelectric.com www.thermoelectric.com

Important Installation Notes for Air Conditioners

Mounting Styles: Both 'thru mount' and 'flush mount' units can be positioned in any orientation and on any enclosure surface. It is important to consider interior air flow patterns when determining the mounting location. Also of importance is an unrestricted flow of ambient air thru the hot side heat exchanger. Ease of access and inspection must be considered for those applications in particularly severe environments which may require occasional maintenance.

Vertical (Side/Front/Back) Mounting:

Vertical mounting refers to the vertical direction of the cold side or interior fins and is recommended for applications with high humidity, poor and incomplete cabinet seals or any condition which may cause the cold side fins to be maintained at temperatures below the dew point for long periods of time allowing for the formation of condensation. The vertical fin direction provides a drip path whereupon condensation can be collected via a moisture removal system (standard on FHP-units) or a drip pan positioned below the cold side fins. Drip pans are optional for thru mount units.

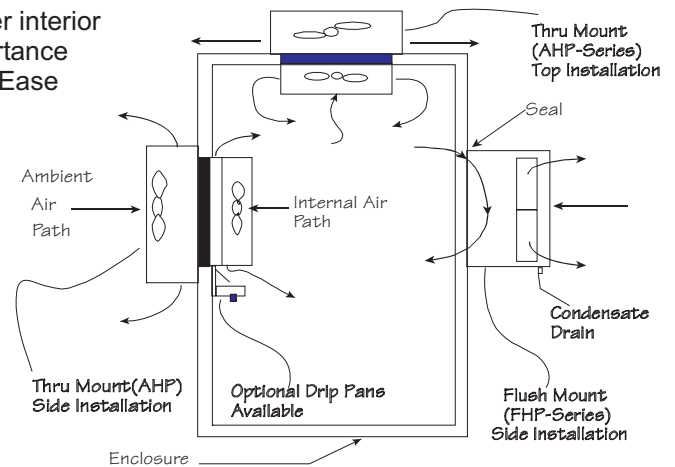

Condensate Removal System:

All FHP-Series and AHP-1400 air conditioners contain a built-in condensate removal system. The condensate kit consists of a antifungal sponge with a condensate wick. PVC tubing is also provided for drainage. Drip pans are optional for thru mount units which must be evaluated on an individual basis. Equations defining a relationship between the cold side fin and enclosure temperatures are provided to assist in the evaluation.

Top Mounting:

Though often the easiest location to mount it is often the most difficult to protect from condensation in this orientation due to the fin orientation, gravity and any susceptible components below. If a drip pan is employed by the end user use caution to place the pan far enough away from the internal fan to minimize the restriction of air flow. The pan should cover the fin ends as well as the fan area. When there is a choice, the vertical orientation is preferred by most users.

Maintenance:

Since the technology is solid-state, there are no filters, compressors, or fluorocarbons to maintain. The only moving parts are the fans. It is recommended for harsh or dirty environments that the heat sinks be cleaned from time to time. This can be accomplished by directing compressed air over the external fins or on NEMA 4 versions by hosing the unit down. This will increase the overall life and performance of the system.

Cautions:

Take care when mounting not to damage the seal between the hot and cold side sinks. Do not attempt to mount a unit to a warped surface or try to make the units mounting surface conform to an unflat surface. Do not pinch or damage any leads when mounting. Do not over tighten any installation screw, use reasonable force. Always mount with any condensate drain down. Do not compress the cold side between the hot side and any other surface. Do not obstruct the airflow on either side. When mounting consider the natural air flows of the enclosure. Connect power only after the installation is complete.

Notes on condensation:

Condensation occurs at the cold side fins when the surface temperature goes below the dew point. To reduce or remove condensate, consider the following:

- Regulate the Fin Temperature above the Dewpoint.
- Keep Enclosure Closed and Sealed from Outside Humidity.
- Use Desiccant (Moisture absorbing Granules.)
- Employ Condensate Removal System/Drip Pans.

If you have any questions regarding your installation, Please feel free to contact our technical department for assistance at 773-342-4900.

LTR	DESCRIPTION	DATE	APPROVED
A	ADD METRIC DIMENSIONS	03.23.90	I.N
B	REVISED TITLE	07.13.90	I.N
C	CORRECTED $\frac{1.34}{(44)}$ TO $\frac{1.34}{(34)}$	09.10.92	I.N

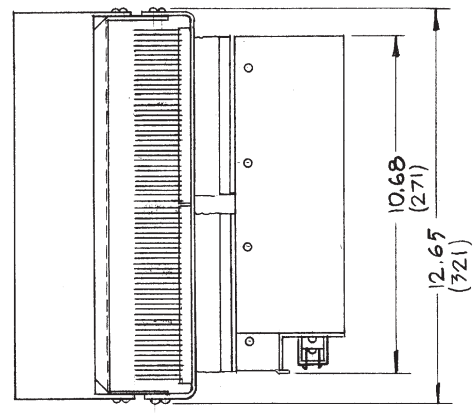

NOTE: DIMENSIONS IN INCHES
(MILLIMETERS)

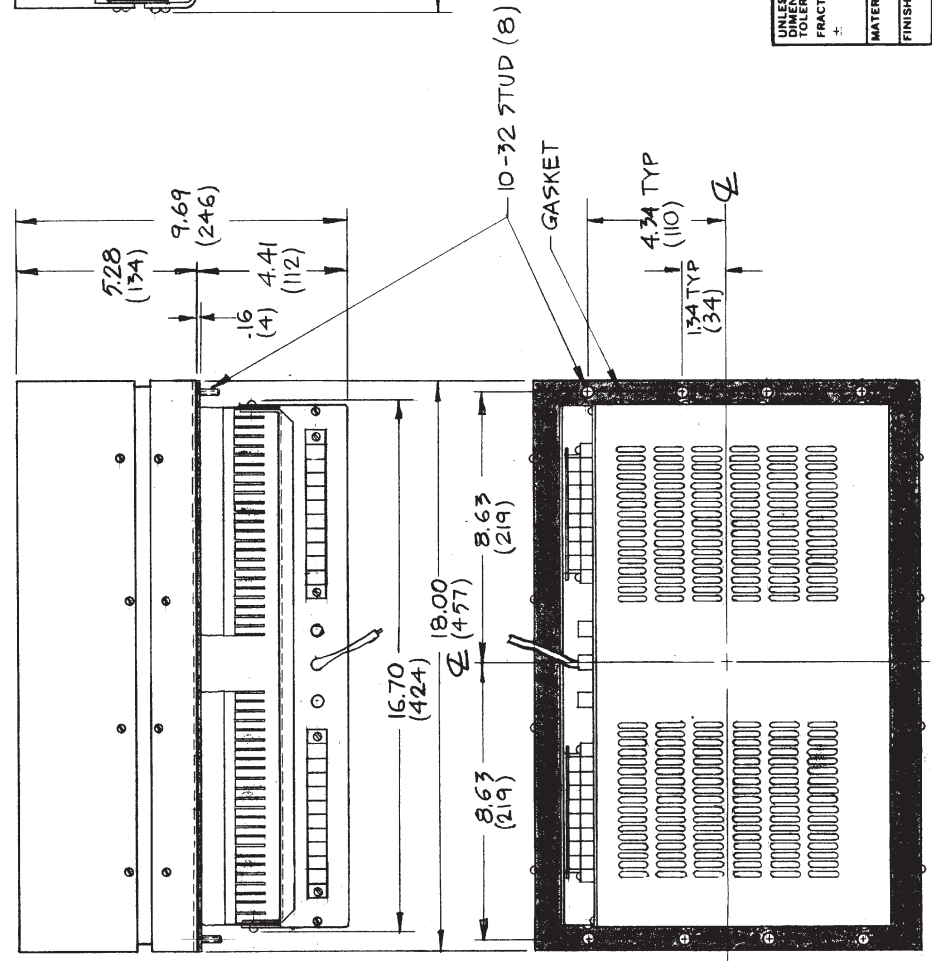

 ThermoElectric Cooling America Corp.	
AHP 1801/1801X ASSEMBLY	
UNLESS OTHERWISE SPECIFIED DIMENSIONS ARE IN INCHES FRACTIONS DECIMALS ANGLES ± .XX ± ± ± MATERIAL .XXX ± ± ± FINISH	DRAWING NO. 1800 - B - A18
APPROVALS DATE 1.23.90	SCALE 1/4
DRAWN I.N. CHECKED	SHEET 1291 OF

AHP-1800 Air Conditioner

Air Cooled
Thru Mount
NEMA-12, 4, 4X

120 VAC, 240 VAC Input



FEATURES

- Compact, (18" L X 12.35" W X 9.69" D)
- Excels in high ambient temperatures
- Environmentally Safe
- Dual voltage versions available, consult factory.
- No compressor, fluorocarbons or filters
- Virtually maintenance-free operation
- Stainless steel exterior housing
- Versions to withstand corrosive environments, shock and vibration
- Mounts and operates in any orientation

INCLUDES

- Adjustable temperature control
- Mounting gasket and hardware
- Power input line cord

OPTIONS

- Other temperature settings for single set point controls
- Custom finishes

SPECIFICATIONS



	MODEL	PART NUMBER	PERFORMANCE RATING BTU/HR	VOLTAGE VAC 50/60 HZ	CURRENT AMPS.	WEIGHT LBS.(KG)	TEMP. CONTROL	OPERATING AMBIENT TEMPERATURE RANGE °C	OPERATING ENCLOSURE TEMPERATURE RANGE °C	AGENCY APPROVALS
NEMA 12	AHP-1800	0-0180-0-000	1035-1180	120	8.0	46(21)	TC-6F	-40/+65	-10/+60	UL1995/CSA22.2
	AHP-1800	0-0150-0-000	1035-1180	120	8.0	46(21)	EXT*	-40/+65	-10/+60	UL1995/CSA22.2
	AHP-1800	0-01F0-0-000	1035-1180	120	8.0	46(21)	85°F (30°C)	-40/+65	-10/+60	UL1995/CSA22.2
	AHP-1800HC	0-0130-1-000	1035-1180	120	8.0	46(21)	TC-3F	-40/+65	-10/+60	UL1995/CSA22.2
	AHP-1800HC	0-0150-1-000	1035-1180	120	8.0	46(21)	EXT*	-40/+65	-10/+60	UL1995/CSA22.2
	AHP-1802	0-0182-0-000	1035-1180	240	5.0	46(21)	TC-6F†	-40/+65	-10/+60	UL1995/CSA22.2
	AHP-1802	0-0152-0-000	1035-1180	240	5.0	46(21)	EXT*	-40/+65	-10/+60	UL1995/CSA22.2
	AHP-1802	0-01F2-0-000	1035-1180	240	5.0	46(21)	85°F (30°C)	-40/+65	-10/+60	UL1995/CSA22.2
	AHP-1802HC	0-0132-1-000	1035-1180	240	5.0	46(21)	TC-3F	-40/+65	-10/+60	UL1995/CSA22.2
	AHP-1802HC	0-0152-1-000	1035-1180	240	5.0	46(21)	EXT*	-40/+65	-10/+60	UL1995/CSA22.2
	AHP-1801	0-0181-0-000	1035-1180	120/240	8.0/5.0	46(21)	TC-6F†	-40/+65	-10/+60	UL1995/CSA22.2
	AHP-1801	0-01F1-0-000	1035-1180	120/240	8.0/5.0	46(21)	85°F (30°C)	-40/+65	-10/+60	UL1995/CSA22.2
NEMA 4	AHP-1801HC	0-0131-1-000	1035-1180	120/240	8.0/5.0	46(21)	TC-3F	-40/+65	-10/+60	UL1995/CSA22.2
	AHP-1800XE	0-0180-4-000	1035-1180	120	8.0	47(21.4)	TC-6F	-40/+65	-10/+60	UL1995/CSA22.2
	AHP-1800XE	0-0150-4-000	1035-1180	120	8.0	47(21.4)	EXT*	-40/+65	-10/+60	UL1995/CSA22.2
	AHP-1800XE	0-01F0-4-000	1035-1180	120	8.0	47(21.4)	85°F (30°C)	-40/+65	-10/+60	UL1995/CSA22.2
	AHP-1800XEHC	0-0130-5-000	1035-1180	120	8.0	47(21.4)	TC-3F	-40/+65	-10/+60	UL1995/CSA22.2
	AHP-1800XEHC	0-0150-5-000	1035-1180	120	8.0	47(21.4)	EXT*	-40/+65	-10/+60	UL1995/CSA22.2
	AHP-1802XE	0-0182-4-000	1035-1180	240	5.0	52(23.6)	TC-6F†	-40/+65	-10/+60	UL1995/CSA22.2
	AHP-1802XE	0-0152-4-000	1035-1180	240	5.0	52(23.6)	EXT*	-40/+65	-10/+60	UL1995/CSA22.2
	AHP-1802XE	0-01F2-4-000	1035-1180	240	5.0	52(23.6)	85°F (30°C)	-40/+65	-10/+60	UL1995/CSA22.2
	AHP-1802XEHC	0-0132-5-000	1035-1180	240	5.0	52(23.6)	TC-3F	-40/+65	-10/+60	UL1995/CSA22.2
	AHP-1802XEHC	0-0152-5-000	1035-1180	240	5.0	52(23.6)	EXT*	-40/+65	-10/+60	UL1995/CSA22.2
	NEMA 4X	AHP-1800X	0-0180-2-000	1035-1180	120	8.0	47(21.4)	TC-6F	-40/+65	-10/+60
AHP-1800X		0-0150-2-000	1035-1180	120	8.0	47(21.4)	EXT*	-40/+65	-10/+60	UL1995/CSA22.2
AHP-1800X		0-01F0-2-000	1035-1180	120	8.0	47(21.4)	85°F (30°C)	-40/+65	-10/+60	UL1995/CSA22.2
AHP-1800XHC		0-0130-3-000	1035-1180	120	8.0	47(21.4)	TC-3F	-40/+65	-10/+60	UL1995/CSA22.2
AHP-1800XHC		0-0150-3-000	1035-1180	120	8.0	47(21.4)	EXT*	-40/+65	-10/+60	UL1995/CSA22.2
AHP-1801X		0-0181-2-000	1035-1180	120/240	8.0/6.0	47(21.4)	TC-6F†	-40/+65	-10/+60	UL1995/CSA22.2
AHP-1801X		0-01F1-2-000	1035-1180	120/240	8.0/6.0	47(21.4)	85°F (30°C)	-40/+65	-10/+60	UL1995/CSA22.2
AHP-1801XHC		0-0131-3-000	1035-1180	120/240	8.0/6.0	47(21.4)	TC-3F	-40/+65	-10/+60	UL1995/CSA22.2

* Unit is set for 5-32 VDC external signal, relay(s) included

Consult factory for shock and vibration models

† Unit evaluated by ETL

AHP-1800

PERFORMANCE CURVE

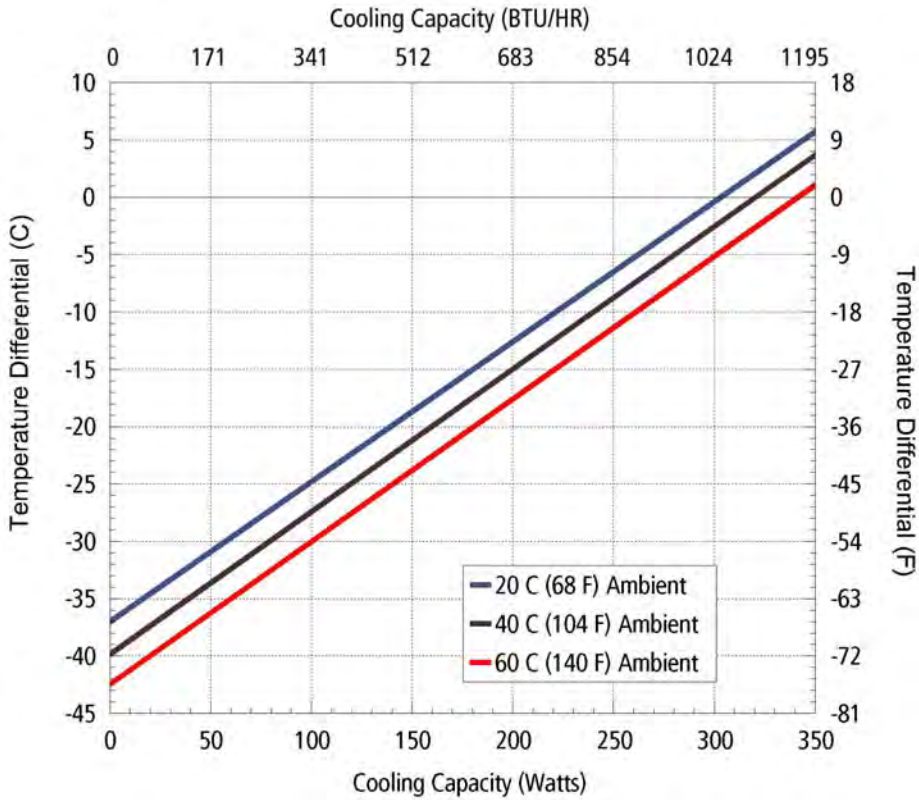

Equation of line: $y = \Delta T(^{\circ}C) \quad x = \text{Capacity (Watts)}$

Ambient Temp	20°C	40°C	60°C
Enclosure Air	$y = .122x - 37.0$	$y = .122x - 39.7$	$y = .122x - 42.3$
Cold Sink	$y = .09x - 37.0$	$y = .09x - 39.7$	$y = .09x - 42.3$

MOUNTING STYLE

Thru Mount

ENVIRONMENTS SERVED

NEMA-12 IP 52

NEMA-4,4X IP 56

RATING (TRADITIONAL)

1100 BTU/hr @ 0 °F ΔT

1420 BTU/hr @ +20 °F ΔT *

RATING (DIN 3168)

322 Watts L35 L35

210 Watts L35 L50

* See page 10

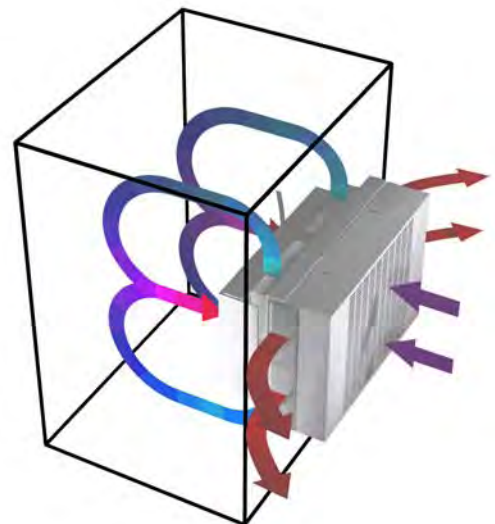

Air Flow Pattern

DIMENSIONS

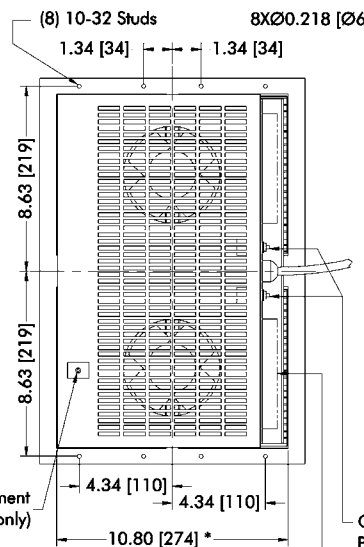
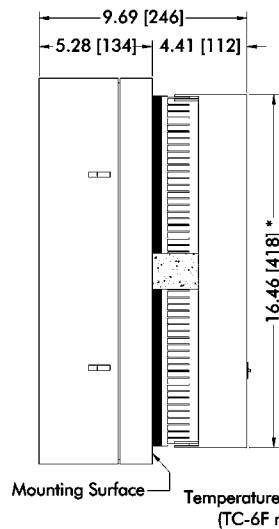
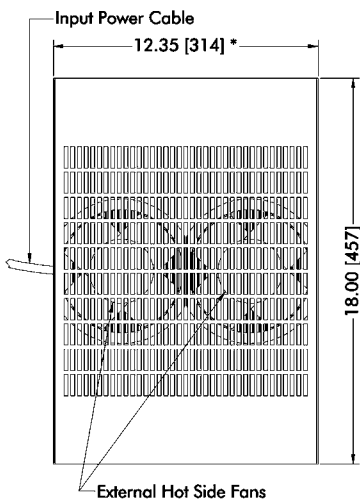

MOUNTING CUTOUT DIMENSIONS

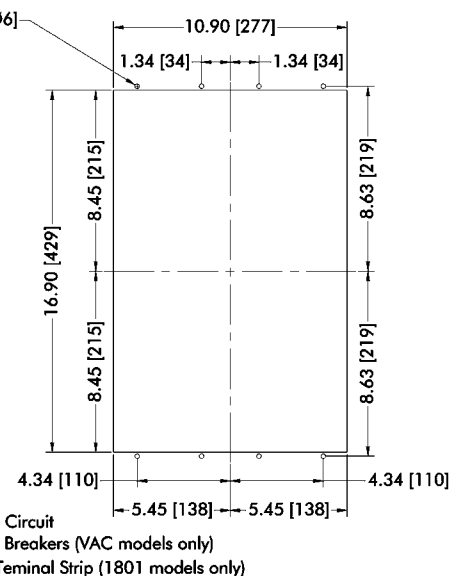

* Dimension does not include hardware and sealant.
Mounting hardware and gasket included but not shown.
Dimensions: Inches [Millimeters]

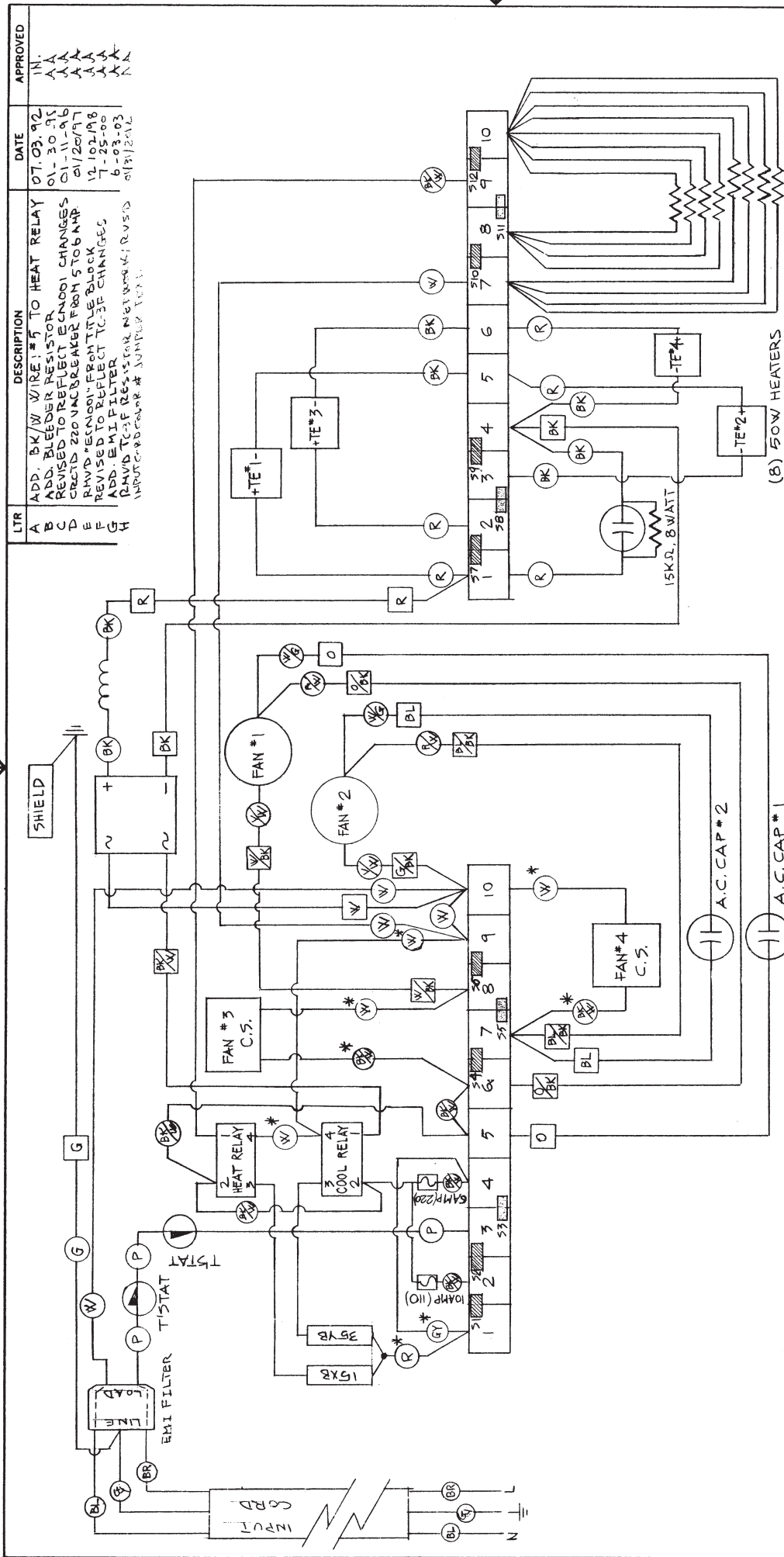

LTR	DESCRIPTION	DATE	APPROVED
A	ADD. BK/W WIRE #5 TO HEAT RELAY	07.09.92	IN.
B	ADD. BLEEDER RESISTOR	01.30.95	AA
C	REVISED TO REFLECT ECM001 CHANGES	01.11.96	AA
D	CRVD 220 VAC BREAKER FROM 5 TO 6 AMP.	01/20/97	AA
E	RHVD "ECM001" FRANTTLE BLOCK	12.10.198	AA
F	REVISED TO REFLECT TC-3E CHANGES	1-25-00	AA
G	ADD. EMI FILTER	8-03-03	AA
H	REVID TC-3F REAS FOR NEXT WORK; RVS'D INPUT CABLE CAR # JUMPER TYP.	01/12/12	AA

NOTE: ALL LEADS ARE 18 AWG, 1/32, 1/32 PVC INSULATION, EXCEPT THOSE INDICATED BY A * WHICH ARE 22 AWG, 1/32 PVC INSULATION

□ INDICATES PLENUM CABLE

UNLESS OTHERWISE SPECIFIED DIMENSIONS ARE IN INCHES

FRACTIONS DECIMALS ANGLES
 .XX ± .015 ±
 .XXX ± .005

MATERIAL
 FINISH

APPROVALS DATE
 DRAWN 11. 07.13.90

CHECKED

leca ThermoElectric Cooling America Corp.

AHP 1801 X HC

WIRING DIAGRAM

SIZE **B**

DRAWING NO. **1800 - B - E13**

SCALE **D1379**

SHEET **OF**

Mounting, Montage, Deutsch, Italiano

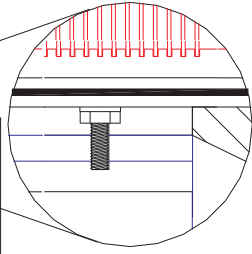
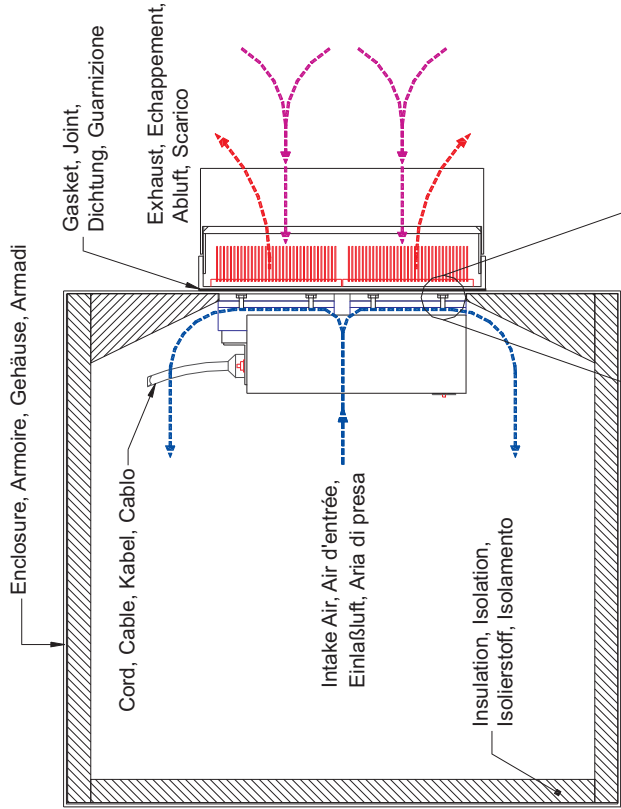
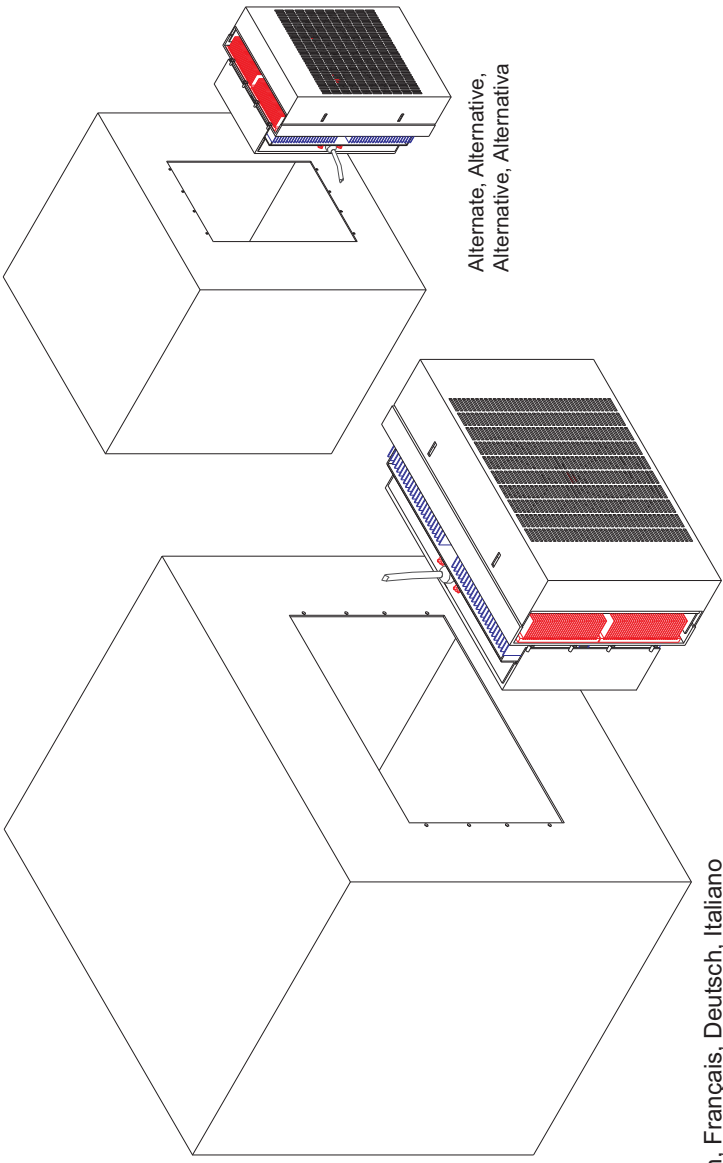

5.45 [138.4]
 4.34 [110.2]
 1.34 [34.0] → Ø0.22 [Ø5.5]

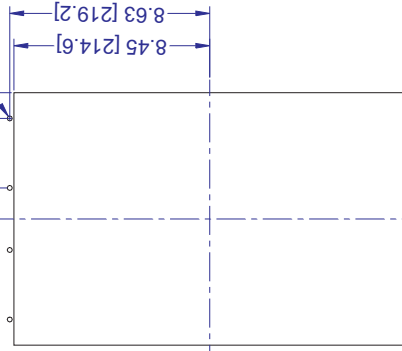

English, Français, Deutsch, Italiano Dimensions: Inches [Millimeters]

Warning - If the supply cord is damaged, it must be replaced by the manufacturer, its service agent or similarly qualified persons in order to avoid a hazard.
 - UL 489 defines branch circuit protection of no more than 4X the rating of the supplemental protector to be used upstream. We suggest a slow reacting, 10-15 Amps circuit breaker.
 - This appliance is not intended for use by persons (including children) with reduced physical, sensory or mental capabilities, or lack of experience and knowledge, unless they have been given supervision or instruction concerning use of the appliance by a person responsible for their safety.
 Children should be supervised to ensure that they do not play with the appliance.

Avertissement - Si le cordon d'alimentation est endommagé, il doit être remplacé par le fabricant, son agent de service ou de personnes de qualification similaire afin d'éviter un danger.
 - UL 489 définit la protection du circuit de pas plus de 4X la cote du protecteur supplémentaire pour être utilisé en amont. Nous suggérons une lente réaction, 10-15 disjoncteurs Amps.
 - Cet appareil n'est pas destiné à être utilisé par des personnes (enfants compris) dont les capacités physiques, sensorielles ou mentales, ou le manque d'expérience et de connaissances, à moins qu'ils aient été donnés de surveillance ou d'instructions concernant l'utilisation de l'appareil par une personne responsable de leur sécurité.
 Les enfants doivent être surveillés afin de s'assurer qu'ils ne jouent pas avec l'appareil.

Achtung - Wenn das Netzkabel beschädigt ist, muss es durch den Hersteller, seinen Kundendienst oder eine ähnlich qualifizierte Person, um eine Gefahr zu vermeiden ersetzt werden.
 - UL 489 definiert den Schutz der Stromzweige nicht mehr als 4X das Rating der Beschützer weiter flussaufwärts genutzt werden. Wir empfehlen eine langsame Reaktion, 10-15 Ampere-Sicherung.
 - Dieses Gerät ist nicht für die Verwendung durch Personen (einschließlich Kinder) mit eingeschränkten physischen, sensorischen oder geistigen Fähigkeiten oder Mangel an Erfahrung und Wissen, bestimmt, sofern sie eine angemessene Aufsicht oder ausführende Anleitung zur Benutzung des Geräts durch eine verantwortliche Person für ihre Sicherheit. Kinder sollten beaufsichtigt werden, um sicherzustellen, dass sie nicht mit dem Gerät spielen.

Attenzione - Se il cavo di alimentazione è danneggiato, esso deve essere sostituito dal produttore, dal suo agente di servizio o da un professionista al fine di evitare rischi.
 - UL 489 definisce il circuito di protezione filare di non più di 4X il rating del protettore supplementare da utilizzare a monte. Vi suggeriamo una lenta reazione, 10-15 interruttore Amp.
 - Questo apparecchio non è destinato all'uso da parte di persone (bambini compresi) con ridotte capacità fisiche, sensoriali o mentali, o mancanza di esperienza e conoscenza, a meno che non siano sorvegliati o istruzioni per l'uso dell'apparecchio da una persona responsabile della loro sicurezza.
 I bambini devono essere supervisionati per assicurarsi che non giochino con l'apparecchio.

INFORMATION DISCLOSED HEREIN IS THE CONFIDENTIAL PROPERTY OF TECA CORP. RECIPIENT SHALL NOT USE THE INFORMATION IN ANY UNAUTHORIZED MANNER. FINISH:		UNLESS OTHERWISE SPECIFIED DIMENSIONS ARE IN INCHES TOLERANCES ARE: DECIMALS ANGLE +/- .XX +/- FRACTION +/- .XXX +/- MATERIAL:	
THERMOELECTRIC COOLING AMERICA CORP.			
AHP-1800 SERIES TYPICAL FIELD MOUNTING			
DRAWN BY:	AA	DRAWING #	REV LEVEL
DATE:	06/05/03	1800-A-F49	A
	D6037	SCALE	SHEET
		MASTER:	MASTER

A	Added UL489 branch circuit protection note and added unqualified operator and supervision note.	Date	01/24/2012	AA	APPROVED
REV	DESCRIPTION				

Control/Thermostats

The model **TC-6F** (Cool Only) thermostat is designed using two magnetic reed switches in conjunction with a solid state relay. A three position switch is provided to adjust between the following settings:

Position	Control Temp.	Tolerance	Reset Differential
1	35°C	+/-5°C	10°C Maximum
2	25°C	+/-5°C	10°C Maximum
3	Constant On		

The model **TC-3F** (Heat/Cool) thermostat incorporates the same technology as the TC-6F. It contains a single setting each for both heating and cooling as referenced below:

Mode	Control Temp.	Tolerance	Reset Differential
Cooling	35°C	+/-5°C	-10°C Maximum
Heating	15°C	+/-5°C	+10°C Maximum

LIMITED WARRANTY

In the event a defect in material or workmanship is discovered in any of TECA's products within one year after the date they are delivered to Buyer, and if: (a) TECA is notified of the defect in writing by certified mail within 14 days of the date of discovery; (b) TECA may then either, at its sole discretion, inspect the product at Buyer's location, or require that the product be made available at Buyer's expense at TECA's premises for TECA's inspection within 14 days of the date of notification; and (c) the products are defective and the defects result from faulty materials and/or workmanship and not in any way from accident, misuse, misapplication, mishandling, modification, or alteration by the Buyer or the shipper, then TECA shall, at its sole option, repair or exchange defective products free of charge to Buyer, or credit to buyer the price of the defective products. ALL OTHER WARRANTIES, EXPRESS OR IMPLIED, ARE EXCLUDED, INCLUDING BUT NOT LIMITED TO THE IMPLIED WARRANTIES OF MERCHANTABILITY AND FITNESS FOR A PARTICULAR PURPOSE. IN NO EVENT SHALL TECA BE LIABLE FOR ANY CLAIM BASED UPON BREACH OF EXPRESS OR IMPLIED WARRANTY OR ANY OTHER DAMAGES WHETHER SPECIAL, INDIRECT, INCIDENTAL, CONSEQUENTIAL, LOST PROFITS, BUSINESS INTERRUPTION, OR LOSS OF BUSINESS OR CUSTOMER RELATIONSHIPS.

RETURNED GOODS, RESTOCKING CHARGES

In order to return merchandise for any reason (repair, replacement, or credit) a return authorization number must be issued by TECA. New merchandise may not be returned for credit beyond 60 days from shipment. Charges for incidental or other damages may also be made. All returned goods must be sent freight prepaid. A restocking charge of 15% will apply. On special equipment and custom modified equipment orders, additional incremental cancellation charges may be made.